

# Short form

**enclosed switches** **switch disconnectors**



For free expert advice  
call our sales team on  
**01635 26 26 26**

[krausnaimer.com](http://krausnaimer.com)

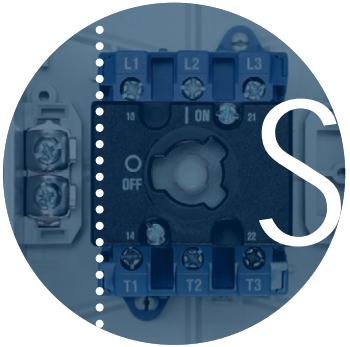

# Short form

The Shortform Catalogue contains both our most popular enclosed switches (pages 4-30) and our best selling open switches switch disconnecter range (pages 31-47)

Kraus & Naimer's Blue Line products are accepted and universally recognised for their quality and workmanship.

In this new edition you will see the introduction of the **article number** column, containing a 7/8 digit code unique to each and every product that we sell:

3 Pole	Article No.	Encl. Ref	Price (£)	3 Pole + Solid Neutral (TP&N)
KG10.T203/GBA270.*KS1V	70050963	KS AV	29.44	KG10.T203/GBA355.*KS1V
KG20.T203/GBA270.*KS1V	70053688	KS AV	31.44	KG20.T203/GBA355.*KS1V

Please start using the article number when ordering as we will shortly be adopting an automatic order entry system which will recognise these numbers.

Kraus & Naimer Limited is part of the worldwide Kraus & Naimer Group which celebrated its 115 year anniversary in 2022.

In 1963, Kraus & Naimer Limited was established as the UK sales and marketing company for Kraus & Naimer switchgear. By the early 70's successful growth meant a move to its current purpose-built premises in Newbury, from which it supplies over 3,000 customers with world-renowned, high quality Blue Line switchgear products.

Our key to success is the outstanding level of technical product support through our dedicated team of internal and external technical sales engineers. With many years experience, training and unbeatable product knowledge the team can find a solution for your switch applications.

# Enclosed Switches

## Enclosed Isolators

<b>Main &amp; Main/Emergency-Off Switch</b>		
Insulated enclosure		4-5
Painted steel enclosure		6-7
Stainless steel enclosure		8-9
Flush mounted stainless steel		10
Interlocked switch socket		11
Sloping roof stainless steel		12-13
GRP enclosure		14-15
GRP All-in-One		16-17
Insulated enclosure, EMC compliant connection		16-17
<b>AC Switch-Disconnectors</b>		
Single & three phase	25 - 40A	18
<b>DC Switch-Disconnectors</b>		
Single string & two string	11 - 50A up to 1000 VDC	19
<b>Changeover Switch with Centre Off</b>		
Insulated, painted mild steel & stainless steel enclosure		20-21
GRP enclosure		22-23
Load Switch, painted mild steel		22-23
<b>Main/Emergency-Off Switch + Emergency Stop Push Button</b>		
Insulated enclosure/painted steel enclosure/Stainless steel enclosure		24
<b>Changeover Switch with Centre Off</b>		
Mains-Off Generator switch with appliance inlet, painted mild steel		25

## Control Stations

<b>Emergency Stop Push Button Station</b>		
Stainless steel enclosure	twist to reset, key operate to reset	26
Painted steel enclosure	twist to reset, key operate to reset	
Stainless steel, flush mount	twist to reset, key operate to reset	
Insulated enclosure	twist to reset, pull to reset palm/foot switch	
<b>Emergency Stop Push Button Station with protective shroud</b>		
Stainless steel enclosure	twist to reset, key operate to reset	27
Painted steel enclosure	twist to reset, key operate to reset	
Stainless steel, flush mount	twist to reset, key operate to reset	
Insulated enclosure	twist to reset, pull to reset palm/foot switch	
<b>Fire Alarm Isolator</b>		
Insulated enclosure - double pole 10A		27
<b>Rotary Control Switch</b>		
Insulated enclosure off/on & changeover switches		28
<b>Key Operated Control Switch</b>		
Insulated enclosure off/on, changeover & step switches		28

## Load Switches

<b>Emergency-Off Switch</b>		
Insulated enclosure 3 & 4 pole	25A & 32A	28
<b>Motor Reversing Switch</b>		
Insulated enclosure 3 phase/1 phase motors		28

## Technical Data & Additional Information

Options & Additional Information	
Technical Data	29
IP rating information	30

# Switch-disconnectors open switches (pages 31 - 47)

# Main/emergency-off switch 20A - 315A



3, 4 & 6 POLE



**IP RATING** IP66/67 protection

**ENCLOSURE** insulated polycarbonate grey (RAL7035)

**HANDLE OPTION** red & yellow padlockable handle optional  
black handle available

**EARTH TERMINAL** included

**SAFETY FEATURE** switch is interlocked with the lid to prevent opening in 'ON' position

**ALSO AVAILABLE** 8 Pole

WITHOUT AUXILIARIES

le / AC-21A	3 Pole	Article No.	Encl. Ref	3 Pole + Solid Neutral (TP&N)	Article No.	Encl. Ref
20A	KG10.T203/GBA270.*KS1V	70050963	KSAV	KG10.T203/GBA355.*KS1V	70011636	KSAV
25A	KG20.T203/GBA270.*KS1V	70053688	KSAV	KG20.T203/GBA355.*KS1V	70053680	KSAV
32A	KG32.T203/GBA270.*KS1V	70055087	KSAV	KG32.T203/GBA355.*KS1V	70055089	KSAV
40A	KG41.T203/GBA270.*KL1V	70028993	KLCV	KG41.T203/GBA355.*KL1V	70055415	KLCV
63A	KG64.T203/GBA270.*KL1V	70055420	KLCV	KG64.T203/GBA355.*KL1V	70055421	KLCV
80A	KG80.T203/GBA270.*KL1V	70055095	KLDV	KG80.T203/GBA355.*KL1V	70054636	KLDV
100A	KG100.T203/GBA270.*KL1V	70042549	KLDV	KG100.T203/GBA355.*KL1V	70055022	KLDV
125A	KG105.T203/GBA270.*KL1V	70053863	KLDV	KG105.T203/GBA355.*KL1V	70067975	KLDV
125A <sup>3)</sup>	KG125.T203/GBA270.*ST	70054649	ST3	KG125.T207/GBA355.*ST	70067977	ST3
160A	KG160.T203/GBA270.*ST	70067966	ST3	KG160.T207/GBA355.*ST	70067978	ST3
200A	KG210.T203/GBA270.*ST	70067972	ST3	KG210.T207/GBA355.*ST	70067980	ST4
250A	KG250.T203/GBA270.*ST	70054716	ST3	KG250.T207/GBA355.*ST	70067981	ST4
315A	KG315.T203/GBA270.*ST	70067973	ST3	KG315.T207/GBA355.*ST	70067983	ST4

WITH AUXILIARIES <sup>1</sup>

le / AC-21A	3 Pole + Aux	Article No.	Encl. Ref	3 Pole + Solid Neutral (TP&N) + Aux	Article No.	Encl. Ref
20A	KG10.T203/GBA281.*KS1V	70053682	KSAV	KG10.T203/GBA374.*KS1V	70067990	KSAV
25A	KG20.T203/GBA280.*KS1V	70055049	KSAV	KG20.T203/GBA373.*KS1V	70041855	KSAV
32A	KG32.T203/GBA280.*KS1V	70055088	KSAV	KG32.T203/GBA373.*KS1V	70067996	KSAV
40A	KG41.T203/GBA280.*KL1V	70053718	KLCV	KG41.T203/GBA373.*KL1V	70067998	KLCV
63A	KG64.T203/GBA280.*KL1V	70055094	KLCV	KG64.T203/GBA373.*KL1V	70068000	KLCV
80A	KG80.T203/GBA280.*KL1V	70055097	KLDV	KG80.T203/GBA373.*KL1V	70068020	KLDV
100A	KG100.T203/GBA280.*KL1V	70054638	KLDV	KG100.T203/GBA373.*KL1V	70068021	KLDV
125A	KG105.T203/GBA280.*KL1V	70054648	KLDV	KG105.T203/GBA373.*KL1V	70068026	KLDV
125A <sup>3)</sup>	KG125.T203/GBA065.*ST	70055031	ST3	KG125.T207/GBA110.*ST	70068028	ST3
160A	KG160.T203/GBA065.*ST	70055041	ST3	KG160.T207/GBA110.*ST	70068030	ST3
200A	KG210.T203/GBA070.*ST	70055243	ST3	KG210.T207/GBA120.*ST	70068031	ST4
250A	KG250.T203/GBA070.*ST	70055383	ST3	KG250.T207/GBA120.*ST	70068032	ST4
315A	KG315.T203/GBA070.*ST	70054685	ST3	KG315.T207/GBA120.*ST	70068033	ST4

**Notes**

1) The following auxiliary contacts are provided:-  
 KG10 3 to 6 pole 1 N.O. (early break) + 1 N.C.  
 KG20 to KG105 3 to 6 pole 2 N.O. (early break)  
 KG125 to KG315 3 to 6 pole 2 N.O. (early break) + 2 N.C.

2) Switched neutral pole is early make/late break.

3) KG125 suitable for applications requiring larger cable termination and increased enclosure size than a KG105.



## DIMENSIONS (units = mm throughout the catalogue unless stated otherwise)

Encl. Ref.	Encl. Dim.			Encl. Dim.			Cable Entries.	Line Drg.
	H	W	D	H1	W1	d		
KSAV	120	85	90	110	-	4.2	4 x 20/25mm k'outs	Fig. 1
KLCV	190	100	93	178	-	5.6	4 x 20/25mm k'outs	Fig. 1
KLD	250	145	107	229	124	6.5	4 x 25/40mm k'outs	Fig. 2
KLDV	250	145	107	229	124	6.5	4 x 25/40mm k'outs	Fig. 2
STE	280	190	180	254	164	7	2 x gland plates	Fig. 2
ST2	280	190	130	254	164	7	2 x gland plates	Fig. 2
ST3	380	280	180	354	254	7	2 x gland plates	Fig. 2
ST4	560	380	180	534	354	7	2 x gland plates	Fig. 2

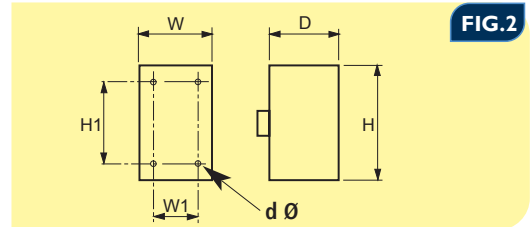
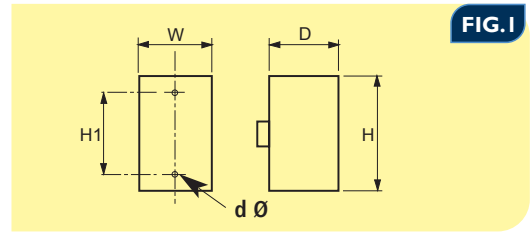

Please refer to Encl. Ref column in tables below for enclosure reference

4 Pole (3ph + Sw N²)		Article No.	Encl. Ref	6 Pole		Article No.	Encl. Ref	le / AC-21A
KG10.T204/GBA290.*KS1V	70053685	KSAV		KG10B.T206/GBA320.*KS1V	70055029	KSAV		20A
KG20.T204/GBA290.*KS1V	70029049	KSAV		KG20B.T206/GBA320.*KL1V	70053713	KLCV		25A
KG32.T204/GBA290.*KS1V	70011240	KSAV		KG32B.T206/GBA320.*KL1V	70054640	KLCV		32A
KG41.T204/GBA290.*KL1V	70036915	KLCV		KG41B.T206/GBA320.*KL1V	70040817	KLDV		40A
KG64.T204/GBA290.*KL1V	70028994	KLCV		KG64B.T206/GBA320.*KL1V	70054241	KLDV		63A
KG80.T204/GBA290.*KL1V	70028995	KLDV		KG80.T206/GBA967.*ST	70067987	STE		80A
KG100.T204/GBA290.*KL1V	70028986	KLDV		KG100.T206/GBA967.*ST	70067988	STE		100A
KG105.T204/GBA290.*KL1V	70055027	KLDV		KG105.T206/GBA967.*ST	70067995	STE		125A
KG125.T204/GBA290.*ST	70055385	ST3		KG125.T206/GBA967.*ST	70067991	ST4		125A <sup>3)</sup>
KG160T204/GBA290.*ST	70055449	ST3		KG160.T206/GBA967.*ST	70067993	ST4		160A
KG210.T204/GBA290.*ST	70067984	ST4						200A
KG250.T204/GBA290.*ST	70055235	ST4						250A
KG315.T204/GBA290.*ST	70067986	ST4						315A

4 Pole (3ph + Sw N²) + Aux		Article No.	Encl. Ref	6 Pole + Aux		Article No.	Encl. Ref	le / AC-21A
KG10.T204/GBA311.*KS1V	70053708	KSAV		KG10.T206/40.KS51V	70008385	KSAV		20A
KG20.T204/GBA310.*KS1V	70054540	KSAV		KG20B.T206/GBA330.*KL1V	70055086	KLCV		25A
KG32.T204/GBA310.*KS1V	70054000	KSAV		KG32B.T206/GBA330.*KL1V	70045708	KLCV		32A
KG41.T204/GBA310.*KL1V	70055419	KLCV		KG41B.T206/GBA330.*KL1V	70054567	KLDV		40A
KG64.T204/GBA310.*KL1V	70054060	KLCV		KG64B.T206/GBA330.*KL1V	70055485	KLDV		63A
KG80.T204/GBA310.*KL1V	70054555	KLDV		KG80.T206/GBA907.*ST	70055246	STE		80A
KG100.T204/GBA310.*KL1V	70054124	KLDV		KG100.T206/GBA907.*ST	70054639	STE		100A
KG105.T204/GBA310.*KL1V	70055234	KLDV		KG105.T206/GBA907.*ST	70068066	STE		125A
KG125.T204/GBA075.*ST	70055296	ST3		KG125.T206/GBA085.*ST	70055039	ST4		125A <sup>3)</sup>
KG160.T204/GBA075.*ST	70055227	ST3		KG160.T206/GBA085.*ST	70055044	ST4		160A
KG210.T204/GBA080.*ST	70040618	ST4						200A
KG250.T204/GBA080.*ST	70055290	ST4						250A
KG315.T204/GBA080.*ST	70055289	ST4						315A



# OFF-ON / SWITCH DISCONNECTORS

## Main/emergency-off switch 20A - 315A



3, 4, & 6 POLE



**IP RATING** IP66 protection

**ENCLOSURE** grey paint finish (RAL7032)

**HANDLE OPTION** red & yellow padlockable handle  
optional black handle available

**EARTH TERMINAL** included + lid bonding link

**SAFETY FEATURE** switch is interlocked with the lid to prevent opening in 'ON' position

**ALSO AVAILABLE** 9 & 12 Pole

WITHOUT AUXILIARIES

le / AC-21A	3 Pole	Article No.	3 Pole + Solid Neutral (TP&N)	Article No.
20A	KG10.T203/GBA119.*MB2	70062175		
25A	KG20.T203/GBA119.*MB2	70062176	KG20.T207/GBA170.*MB2	70063733
32A	KG32.T203/GBA119.*MB2	70062177	KG32.T207/GBA170.*MB2	70063734
40A	KG41.T203/GBA109.*MB2	70062178	KG41.T207/GBA170.*MB2	70063736
63A	KG64.T203/GBA109.*MB2	70062179	KG64.T207/GBA170.*MB2	70063737
80A	KG80.T203/GBA109.*MB3	70062452	KG80.T207/GBA170.*MB3	70063738
100A	KG100.T203/GBA109.*MB3	70062239	KG100.T207/GBA170.*MB3	70063739
125A	KG105.T203/GBA109.*MB3	70062242	KG105.T207/GBA170.*MB3	70063741
125A <sup>3)</sup>	KG125.T203/GBA109.*MB8	70062725	KG125.T207/GBA170.*MB8	70077045
160A	KG160.T203/GBA109.*MB8	70075171	KG160.T207/GBA170.*MB8	70075134
200A	KG210.T203/GBA109.*MB9	70075172	KG210.T207/GBA170.*MB9	70075173
250A	KG250.T203/GBA109.*MB9	70062249	KG250.T207/GBA170.*MB9	70075177
275A				
315A	KG315.T203/GBA109.*MB9	70069904	KG315.T207/GBA170.*MB9	70075178

WITH AUXILIARIES <sup>1</sup>

le / AC-21A	3 Pole + Aux	Article No.	3 Pole + Solid Neutral (TP&N)+Aux	Article No.
20A	KG10.T203/GBA168.*MB2	70062251		
25A	KG20.T203/GBA169.*MB2	70062252	KG20.T207/GBA175.*MB2	70063749
32A	KG32.T203/GBA169.*MB2	70062263	KG32.T207/GBA175.*MB2	70063750
40A	KG41.T203/GBA159.*MB2	70062304	KG41.T207/GBA175.*MB2	70063751
63A	KG64.T203/GBA159.*MB2	70062305	KG64.T207/GBA175.*MB2	70063752
80A	KG80.T203/GBA159.*MB3	70062307	KG80.T207/GBA175.*MB3	70063755
100A	KG100.T203/GBA159.*MB3	70062308	KG100.T207/GBA175.*MB3	70063756
125A	KG105.T203/GBA159.*MB3	70062309	KG105.T207/GBA175.*MB3	70063757
125A <sup>3)</sup>	KG125.T203/GBA165.*MB8	70062310	KG125.T207/GBA180.*MB8	70075247
160A	KG160.T203/GBA165.*MB8	70062356	KG160.T207/GBA180.*MB8	70075251
200A	KG210.T203/GBA175.*MB9	70062357	KG210.T207/GBA185.*MB9	70075253
250A	KG250.T203/GBA175.*MB9	70062358	KG250.T207/GBA185.*MB9	70075255
275A				
315A	KG315.T203/GBA175.*MB9	70062359	KG315.T207/GBA185.*MB9	70063764

## Main switch (with larger enclosure) 250A - 1250A

le / AC-21A	3 Pole + Aux	Article No.	3 Pole + Neutral Link + Aux	Article No.
250A	GB2.250/A.3011ST02.*MB25	5507848	GB2.250/A.3111ST02.*MB25	5507855
315A	GB2.315/A.3011ST02.*MB26	5507849	GB2.315/A.3111ST02.*MB26	5507856
400A	GB2.400/A.3011ST02.*MB26	5507850	GB2.400/A.3111ST02.*MB26	5507857
630A	GB2.630/A.3011ST02.*MB27	5507851	GB2.630/A.3111ST02.*MB27	5507858
800A	GB2.800/A.3011ST02.*MB28	5507852	GB2.800/A.3111ST02.*MB28	5507859
1000A	GB2.1000/A.3011ST02.*MB28	5507853	GB2.1000/A.3111ST02.*MB28	5507860
1250A	GB2.1250/A.3011ST02.*MB28	5507854	GB2.1250/A.3111ST02.*MB28	5507861

# MILD STEEL enclosure



## DIMENSIONS

Encl. Ref.	Encl. Dim.				Encl. Dim.			Cable Entries.	Line Drg.
	H	W	D	D1	H1	W1	d		
MB2	194	119	115	8	133	137	6	-	Fig. 1
MB3	254	149	125	8	193	167	6	-	Fig. 1
MB4	309	234	150	8	248	252	6	-	Fig. 1
MB8	400	300	175	-	340	240	6.5	2 x gland plates	Fig. 1
MB9	500	400	175	-	440	340	6.5	2 x gland plates	Fig. 1
MB10	500	400	300	-	440	340	6.5	2 x gland plates	Fig. 1
MB20	250	175	175	-	225	195	6	-	Fig. 1
MB25	650	450	225	-	590	390	6.5	2 x gland plates	Fig. 2
MB26	800	550	225	-	740	490	6.5	2 x gland plates	Fig. 2
MB27	900	600	300	-	840	540	6.5	2 x gland plates	Fig. 2
MB28	1000	800	400	-	940	740	6.5	4 x gland plates	Fig. 2
MB29	750	450	300	-	690	390	6.5	2 x gland plates	Fig. 2

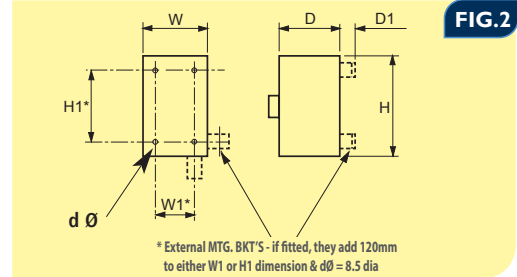
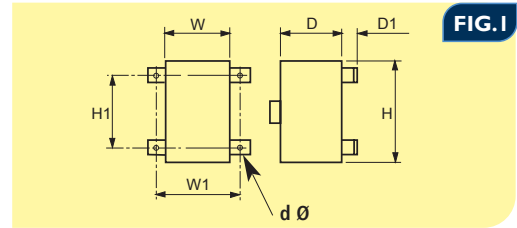

Please refer to end of part no. for enclosure reference. See tables below:

4 Pole (3ph + Sw N <sup>2</sup> )		Article No.	6 Pole		Article No.	le / AC-21A
KG10.T204/GBA219.*MB2	70062368		KG20B.T206/GBA309.*MB2	70062496		25A
KG20.T204/GBA219.*MB2	70062369		KG32B.T206/GBA309.*MB2	70062504		32A
KG32.T204/GBA219.*MB2	70062370		KG41B.T206/GBA309.*MB3	70062508		40A
KG41.T204/GBA209.*MB2	70062371		KG64B.T206/GBA309.*MB3	70062511		63A
KG64.T204/GBA209.*MB2	70062373		KG80.T206/GBA309.*MB4	70062514		80A
KG80.T204/GBA209.*MB3	70062374		KG100.T206/GBA309.*MB4	70062516		100A
KG100.T204/GBA209.*MB3	70062375		KG105.T206/GBA309.*MB4	70062518		125A
KG105.T204/GBA209.*MB3	70062376		KG125.T206/GBA309.*MB9	70062520		125A <sup>3)</sup>
KG125.T204/GBA209.*MB8	70062421		KG160.T206/GBA309.*MB9	70062522		160A
KG160.T204/GBA209.*MB8	70062431		C200-4.T206/GBA309.*MB10	70062645		200A
KG210.T204/GBA209.*MB9	70062378					
KG250.T204/GBA209.*MB9	70062379					
			C316.T206/GBA309.*MB10	70062605		275A
KG315.T204/GBA209.*MB9	70062437		C316.T206/GBA309.*MB29	70062606		315A
4 Pole (3ph + Sw N <sup>2</sup> ) + Aux		Article No.	6 Pole + Aux		Article No.	le / AC-21A
KG10.T204/GBA268.*MB2	70062382		KG20B.T206/GBA359.*MB2	70062660		20A
KG20.T204/GBA269.*MB2	70062385		KG32B.T206/GBA359.*MB2	70062665		25A
KG32.T204/GBA269.*MB2	70062386		KG41B.T206/GBA359.*MB3	70062666		32A
KG41.T204/GBA259.*MB2	70062388		KG64B.T206/GBA359.*MB3	70062669		40A
KG64.T204/GBA259.*MB2	70062389		KG80.T206/GBA359.*MB4	70062676		63A
KG80.T204/GBA259.*MB3	70062390		KG100.T206/GBA359.*MB4	70062678		80A
KG100.T204/GBA259.*MB3	70062391		KG105.T206/GBA359.*MB4	70062678		100A
KG105.T204/GBA259.*MB3	70062392		KG125.T206/GBA365.*MB9	70062682		125A
KG125.T204/GBA265.*MB8	70062393		KG160.T206/GBA365.*MB9	70062683		125A <sup>3)</sup>
KG160.T204/GBA265.*MB8	70062397		C200-4.T206/GBA385.*MB10	70062684		160A
KG210.T204/GBA275.*MB9	70062398					200A
KG250.T204/GBA275.*MB9	70062399					250A
			C316.T206/GBA006.*MB10	70062686		275A
KG315.T204/GBA275.*MB9	70062400		C316.T206/GBA365.*MB29	70062687		315A

### IP RATING IP65 with black & red padlockable handle

4 Pole + Aux	Article No.	AC-21A
GB2.250/A.4011ST02.*MB25	5507862	250A
GB2.315/A.4011ST02.*MB26	5507863	315A
GB2.400/A.4011ST02.*MB26	5507864	400A
GB2.630/A.4011ST02.*MB27	5507865	630A
GB2.800/A.4011ST02.*MB28	5507866	800A
GB2.1000/A.4011ST02.*MB28	5507867	1000A
GB2.1250/A.4011ST02.*MB28	5507868	1250A

### Notes

- The following auxiliary contacts are provided:-
  - KG10 1 N.O. (early break) + 1 N.C.
  - KG20 to KG105 2 N.O. (early break)
  - KG125 to KG315 2 N.O. (early break) + 2 N.C.
  - C316/C200-4 2 N.O. (early break)
  - GB2.250/A to GB2.1250/A 1 N.O. (early break) + 1 N.C.
- Switched neutral pole is early make/late break.
- KG125 suitable for applications requiring larger cable termination and increased enclosure size than KG105.

OFF-ON / SWITCH DISCONNECTORS

Main/emergency-off switch 20A - 315A



3, 4 & 6 POLE



**IP RATING** IP66 protection

**ENCLOSURE** brushed stainless steel, grade 316L

**HANDLE OPTION** red & yellow padlockable handle  
optional black handle available

**EARTH TERMINAL** included + lid bonding link

**FEATURE** switch is interlocked with the lid to prevent opening in 'ON' position

WITHOUT AUXILIARIES

le / AC-21A	3 Pole	Article No.	3 Pole + Solid Neutral (TP&N)	Article No.
20A	KG10.T203/GBA419.*SB2	70062692		
25A	KG20.T203/GBA419.*SB2	70062690	KG20.T207/GBA420.*SB2	70063758
32A	KG32.T203/GBA419.*SB2	70062694	KG32.T207/GBA420.*SB2	70063765
40A	KG41.T203/GBA409.*SB2	70062698	KG41.T207/GBA420.*SB2	70063766
63A	KG64.T203/GBA409.*SB2	70062699	KG64.T207/GBA420.*SB2	70063767
80A	KG80.T203/GBA409.*SB3	70062700	KG80.T207/GBA420.*SB3	70063768
100A	KG100.T203/GBA409.*SB3	70062701	KG100.T207/GBA420.*SB3	70063770
125A	KG105.T203/GBA409.*SB3	70062704	KG105.T207/GBA420.*SB3	70063772
125A <sup>3)</sup>	KG125.T203/GBA409.*SB8	70062709	KG125.T207/GBA420.*SB8	70063811
160A	KG160.T203/GBA409.*SB8	70062726	KG160.T207/GBA420.*SB8	70063812
200A	KG210.T203/GBA409.*SB9	70062792	KG210.T207/GBA420.*SB9	70063815
250A	KG250.T203/GBA409.*SB9	70062794	KG250.T207/GBA420.*SB9	70063817
315A	KG315.T203/GBA409.*SB9	70062796	KG315.T207/GBA420.*SB9	70063819

WITH AUXILIARIES <sup>1</sup>

le / AC-21A	3 Pole + Aux	Article No.	3 Pole + Solid Neutral (TP&N) + Aux	Article No.
20A	KG10.T203/GBA468.*SB2	70038454		
25A	KG20.T203/GBA469.*SB2	70062819	KG20.T207/GBA480.*SB2	70063821
32A	KG32.T203/GBA469.*SB2	70062821	KG32.T207/GBA480.*SB2	70063822
40A	KG41.T203/GBA459.*SB2	70062952	KG41.T207/GBA480.*SB2	70063823
63A	KG64.T203/GBA459.*SB2	70062955	KG64.T207/GBA480.*SB2	70063825
80A	KG80.T203/GBA459.*SB3	70062959	KG80.T207/GBA480.*SB3	70063826
100A	KG100.T203/GBA459.*SB3	70062964	KG100.T207/GBA480.*SB3	70063830
125A	KG105.T203/GBA459.*SB3	70062967	KG105.T207/GBA480.*SB3	70063831
125A <sup>3)</sup>	KG125.T203/GBA475.*SB8	70062977	KG125.T207/GBA490.*SB8	70063832
160A	KG160.T203/GBA475.*SB8	70062978	KG160.T207/GBA490.*SB8	70063833
200A	KG210.T203/GBA485.*SB9	70062979	KG210.T207/GBA495.*SB9	70063835
250A	KG250.T203/GBA485.*SB9	70062980	KG250.T207/GBA495.*SB9	70063853
315A	KG315.T203/GBA485.*SB9	70062981	KG315.T207/GBA495.*SB9	70063854

Main switch (with larger enclosure)

250A - 1250A

le / AC-21A	3 Pole + Aux	Article No.	3 Pole + Aux + Neutral Link	Article No.
250A	GB2.250/A.3011ST02.*SB25	5507869	GB2.250/A.3111ST02.*SB25	5507876
315A	GB2.315/A.3011ST02.*SB26	5507870	GB2.315/A.3111ST02.*SB26	5507877
400A	GB2.400/A.3011ST02.*SB26	5507871	GB2.400/A.3111ST02.*SB26	5507878
630A	GB2.630/A.3011ST02.*SB27	5507872	GB2.630/A.3111ST02.*SB27	5507879
800A	GB2.800/A.3011ST02.*SB28	5507873	GB2.800/A.3111ST02.*SB28	5507880
1000A	GB2.1000/A.3011ST02.*SB28	5507874	GB2.1000/A.3111ST02.*SB28	5507881
1250A	GB2.1250/A.3011ST02.*SB28	5507875	GB2.1250/A.3111ST02.*SB28	5507882





## DIMENSIONS

Encl. Ref.	Encl. Dim.				Encl. Dim.			Cable Entries.	Line Drg.
	H	W	D	D1	H1	W1	d		
SB2	194	119	116	-	133	137	6	-	Fig. 1
SB3	254	149	126	-	193	167	6	-	Fig. 1
SB4	309	234	151	-	248	252	6	-	Fig. 1
SB8	400	300	175	-	340	240	6.5	2 x gland plates	Fig. 2
SB9	500	400	175	-	440	340	6.5	2 x gland plates	Fig. 2
SB10	500	400	300	-	440	340	6.5	2 x gland plates	Fig. 2
SB25	650	450	225	-	590	390	6.5	2 x gland plates	Fig. 2
SB26	800	550	225	-	740	490	6.5	2 x gland plates	Fig. 2
SB27	900	600	300	-	840	540	6.5	2 x gland plates	Fig. 2
SB28	1000	800	400	-	940	740	6.5	4 x gland plates	Fig. 2
SB29	750	450	300	-	690	390	6.5	2 x gland plates	Fig. 2

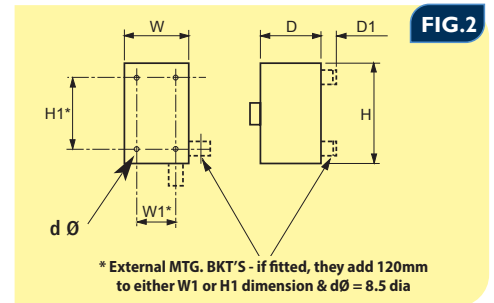
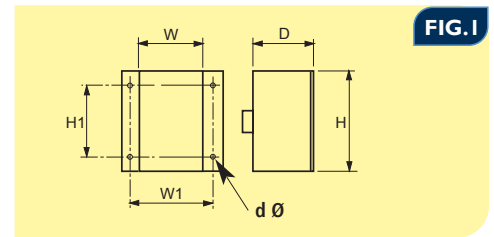

Please refer to end of part no. for enclosure reference. See tables below:

4 Pole (3ph + Sw N <sup>2</sup> )		Article No.	6 Pole		Article No.	le / AC-21A
KG10.T204/GBA519.*SB2	70062983		KG20B.T206/GBA609.*SB2	70063076		20A
KG20.T204/GBA519.*SB2	70063009		KG32B.T206/GBA609.*SB2	70063078		25A
KG32.T204/GBA519.*SB2	70063010		KG41B.T206/GBA609.*SB3	70063081		32A
KG41.T204/GBA509.*SB2	70063011		KG64B.T206/GBA609.*SB3	70063088		40A
KG64.T204/GBA509.*SB2	70063015		KG80.T206/GBA609.*SB4	70063089		63A
KG80.T204/GBA509.*SB3	70063016		KG100.T206/GBA609.*SB4	70063090		80A
KG100.T204/GBA509.*SB3	70063017		KG105.T206/GBA609.*SB4	70063092		100A
KG105.T204/GBA509.*SB3	70063018		KG125.T206/GBA609.*SB9	70063093		125A <sup>3)</sup>
KG125.T204/GBA509.*SB8	70063019		KG160.T206/GBA609.*SB9	70063094		125A <sup>3)</sup>
KG160.T204/GBA509.*SB8	70063021		C200-4.T206/GBA609.*SB10	70063095		160A
KG210.T204/GBA509.*SB9	70063022					200A
KG250.T204/GBA509.*SB9	70063023					250A
KG315.T204/GBA509.*SB9	70063025		C316.T206/GBA609.*SB29	70063096		315A
4 Pole (3ph + Sw N <sup>2</sup> ) + Aux		Article No.	6 Pole + Aux		Article No.	le / AC-21A
KG10.T204/GBA568.*SB2	70063027		KG20B.T206/GBA659.*SB2	70063097		20A
KG20.T204/GBA569.*SB2	70063029		KG32B.T206/GBA659.*SB2	70063098		25A
KG32.T204/GBA569.*SB2	70063030		KG41B.T206/GBA659.*SB3	70063099		32A
KG41.T204/GBA559.*SB2	70063031		KG64B.T206/GBA659.*SB3	70063100		40A
KG64.T204/GBA559.*SB2	70063032		KG80.T206/GBA659.*SB4	70063101		63A
KG80.T204/GBA559.*SB3	70063033		KG100.T206/GBA659.*SB4	70063128		80A
KG100.T204/GBA559.*SB3	70063034		KG105.T206/GBA659.*SB4	70063129		100A
KG105.T204/GBA559.*SB3	70063037		KG125.T206/GBA665.*SB9	70063130		125A <sup>3)</sup>
KG125.T204/GBA565.*SB8	70063038		KG160.T206/GBA665.*SB9	70063132		125A <sup>3)</sup>
KG160.T204/GBA565.*SB8	70063039		C200-4.T206/GBA003.*SB10	70063136		160A
KG210.T204/GBA575.*SB9	70063040					200A
KG250.T204/GBA575.*SB9	70063041					250A
KG315.T204/GBA575.*SB9	70063042		C316.T206/GBA659.*SB29	70063138		315A

## IP RATING IP65 with black & red padlockable handle

4 Pole + Aux		Article No.	le / AC-21A
GB2.250/A.4011ST02.*SB25	5507883		250A
GB2.315/A.4011ST02.*SB26	5507884		315A
GB2.400/A.4011ST02.*SB26	5507885		400A
GB2.630/A.4011ST02.*SB27	5507886		630A
GB2.800/A.4011ST02.*SB28	5507887		800A
GB2.1000/A.4011ST02.*SB28	5507888		1000A
GB2.1250/A.4011ST02.*SB28	5507889		1250A

### Notes

- The following auxiliary contacts are provided:-
 

KG10	1 N.O. (early break) + 1 N.C.
KG20 to KG105	2 N.O. (early break)
KG125 to KG315	2 N.O. (early break) + 2 N.C.
C316/C200-4	2 N.O. (early break)
GB2.250/A to GB2.1250/A	1 N.O. (early break) + 1 N.C.
- Switched neutral pole is early make/late break.
- KG125 suitable for applications requiring larger cable termination and increased enclosure size.

# Main/emergency-off switch 20A - 63A

Flush mounting

2, 3 & 4 POLE



**STAINLESS STEEL** plate with  
**GALVANISED STEEL**  
adaptable box

**IP RATING** IP40 protection (IP65 achievable using suitable sealant)

**MOUNTING PLATE** brushed stainless steel, grade 316L

**HANDLE OPTION** red and yellow padlockable handle  
optional black handle available

## DIMENSIONS

Encl. Ref.	Front Plate			Adaptable Box			Cable Entries
	H	W	T	H1	W1	D	
SF1	100	100	2	78	78	77	8 x 20mm k'outs
SF2	125	125	2	103	103	77	12 x 20mm k'outs
SF3	175	175	2	153	153	102	16 x 20mm k'outs

Please refer to end of part no. for enclosure reference.  
See table below.

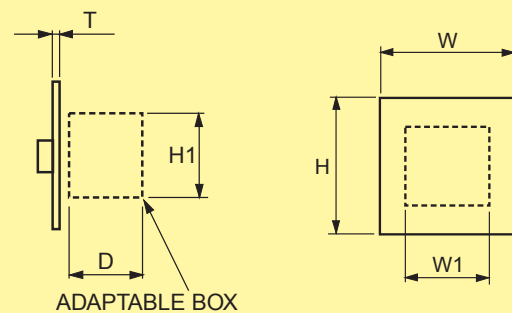

Ie / AC-21A	Order Code No.	Article No.	
<b>2 pole</b>			
20A	KG10.T202/GBA011.*SF1	70063711	
<b>3 pole</b>			
20A	KG10.T203/GBA286.*SF1	70063713	
25A	KG20.T203/GBA286.*SF2	70063715	
32A	KG32.T203/GBA286.*SF2	70063716	
40A	KG41.T203/GBA286.*SF3	70063719	
63A	KG64.T203/GBA286.*SF3	70063724	
<b>4 pole</b>			
20A	KG10.T204/GBA304.*SF1	70063725	
25A	KG20.T204/GBA304.*SF2	70063726	
32A	KG32.T204/GBA304.*SF2	70063728	
40A	KG41.T204/GBA304.*SF3	70063729	
63A	KG64.T204/GBA304.*SF3	70063730	

Ideal for applications where hygiene is a high priority i.e. food and beverage production or hospitals.

Auxiliary contacts available.



32A - 125A

# Interlocked switch socket

Sloping roof enclosure

**IP RATING** IP66 protection

**ENCLOSURE** grade 304L brushed stainless steel sloping roof enclosure

**HANDLE OPTION** IEC 60947 compliant red padlockable handle, padlockable in OFF

**EARTH TERMINAL** included

**SAFETY FEATURE** handle interlocked with the socket, preventing turning the isolator on when no plug is inserted and the removal of the plug while the socket is energised, ensuring safe operation.



## DIMENSIONS

Encl. Ref.	H	W	D
SRM	264	276	164

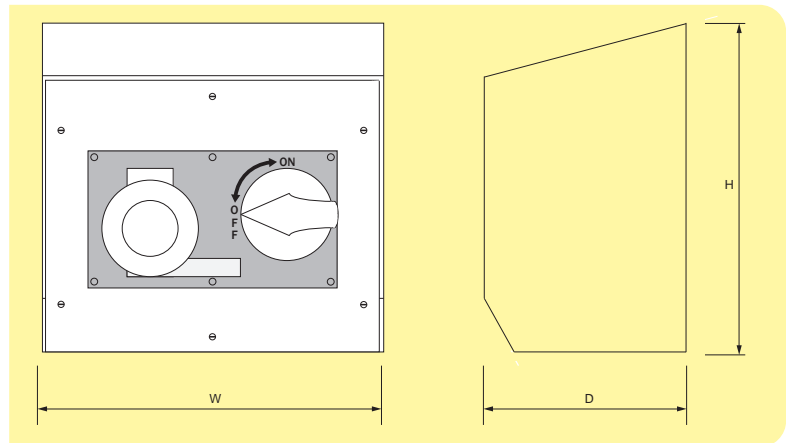

The Outlet socket;  
 for 2 Pole version is 2Pin + E  
 for 3 Pole version is 3Pin + E  
 for 4 Pole version is 4Pin + E

## WITHOUT AUXILIARIES

le / AC-21A	2 Pole 230V	Article No.	3 Pole 400V	Article No.	4 Pole 400V	Article No.
16A	GB2.KH16.T202/GBA3P00.*SRM	5510048	GB2.KH16.T203/GBA4P00.*SRM	5510036	GB2.KH16.T204/GBA5P00.*SRM	5510037
32A	GB2.KH32.T202/GBA3P00.*SRM	5510049	GB2.KH32.T203/GBA4P00.*SRM	5510035	GB2.KH32.T204/GBA5P00.*SRM	5510034

## WITH AUXILIARIES <sup>1</sup>

le / AC-21A	2 Pole (2 n.o. Aux) 230V	Article No.	3 Pole (2 n.o. Aux) 400V	Article No.	4 Pole (2 n.o. Aux) 400V	Article No.
16A	GB2.KH16.T202/GBA3P20.*SRM	5510047	GB2.KH16.T203/GBA4P20.*SRM	5510008	GB2.KH16.T204/GBA5P20.*SRM	5510090
32A	GB2.KF32.T202/GBA3P20.*SRM	5510094	GB2.KF32.T203/GBA4P20.*SRM	5510095	GB2.KF32.T204/GBA5P20.*SRM	5510096
le / AC-21A	2 Pole (1 n.o. + 1 n.c. Aux) 230V	Article No.	3 Pole (1 n.o. + 1 n.c. Aux) 400V	Article No.	4 Pole (1 n.o. + 1 n.c. Aux) 400V	Article No.
16A	GB2.KH16.T202/GBA3P11.*SRM	5510091	GB2.KH16.T203/GBA4P11.*SRM	5510092	GB2.KH16.T204/GBA5P11.*SRM	5510093
32A	GB2.KF32.T202/GBA3P11.*SRM	5510097	GB2.KF32.T203/GBA4P11.*SRM	5510098	GB2.KF32.T204/GBA5P11.*SRM	5510099



# Main/emergency-off switch 25A - 125A

3, 3 + Neutral & 4 POLE



**IP RATING** IP65 protection

**ENCLOSURE** brushed stainless steel, grade 304L with integral canopy

**HANDLE OPTION** red & yellow padlockable handle optional black handle available

**SAFETY FEATURE** switch is interlocked with the lid to prevent opening in 'ON' position

**ADDITIONAL FEATURE** sloping roof

le / AC-21A	AC-23A	Encl. Ref.	3 Pole +2 N.O. Aux	Article No.	3 Pole + solid neutral +2 N.O. Aux	Article No.
25A	7.5kW	SR04	KG20.T203/GBA630.*SR04	70064996	KG20.T207/GBA640.*SR04	70065061
32A	11kW	SR04	KG32.T203/GBA630.*SR04	70064998	KG32.T207/GBA640.*SR04	70065066
25A <sup>2)</sup>	7.5kW	SR14	KG20.T203/GBA601.*SR14	70064999	KG20.T207/GBA603.*SR14	70065106
32A <sup>2)</sup>	11kW	SR14	KG32.T203/GBA601.*SR14	70065000	KG32.T207/GBA603.*SR14	70068084
40A	15kW	SR14	KG41.T203/GBA601.*SR14	70065002	KG41.T207/GBA603.*SR14	70068085
63A	22kW	SR14	KG64.T203/GBA601.*SR14	70065003	KG64.T207/GBA603.*SR14	70068087
80A	30kW	SR24	KG80.T203/GBA601.*SR24	70065004	KG80.T207/GBA603.*SR24	70068089
100A	37kW	SR24	KG100.T203/GBA601.*SR24	70065005	KG100.T207/GBA603.*SR24	70068091
125A	45kW	SR24	KG105.T203/GBA601.*SR24	70065006	KG105.T207/GBA603.*SR24	70068095

# Main/emergency-off switch 25A - 125A

3, 3 + Neutral & 4 POLE



**IP RATING** IP65 protection

**ENCLOSURE** brushed stainless steel, grade 304L, with integral canopy

**HANDLE OPTION** red & yellow padlockable handle optional black handle available

**SAFETY FEATURE** switch is interlocked with the lid to prevent opening in 'ON' position

**ADD. FEATURE** sloping roof with welded mounting plate

le / AC-21A	AC-23A	Encl. Ref.	3 Pole +2 N.O. Aux	Article No.	3 Pole + solid neutral +2 N.O. Aux	Article No.
25A	7.5kW	SR04L	KG20.T203/GBA660.*SR04L	70068123	KG20.T207/GBA670.*SR04L	70068275
32A	11kW	SR04L	KG32.T203/GBA660.*SR04L	70068128	KG32.T207/GBA670.*SR04L	70068277
25A <sup>2)</sup>	7.5kW	SR14L	KG20.T203/GBA601.*SR14L	70068129	KG20.T207/GBA603.*SR14L	70068278
32A <sup>2)</sup>	11kW	SR14L	KG32.T203/GBA601.*SR14L	70068131	KG32.T207/GBA603.*SR14L	70068279
40A	15kW	SR14L	KG41.T203/GBA601.*SR14L	70068132	KG41.T207/GBA603.*SR14L	70068281
63A	22kW	SR14L	KG64.T203/GBA601.*SR14L	70068133	KG64.T207/GBA603.*SR14L	70068285
80A	30kW	SR24L	KG80.T203/GBA601.*SR24L	70068244	KG80.T207/GBA603.*SR24L	70068286
100A	37kW	SR24L	KG100.T203/GBA601.*SR24L	70068246	KG100.T207/GBA603.*SR24L	70068288
125A	45kW	SR24L	KG105.T203/GBA601.*SR24L	70068249	KG105.T207/GBA603.*SR24L	70068289

# SLOPING ROOF - STAINLESS STEEL enclosure



## DIMENSIONS

Encl. Ref.	Front Plate		Side View		
	H1	W1	D1	D2	H2
SR04	170	130	103	122	196
SR14	193	130	132	151	234
SR24	278	185	152	170	324

Please refer to the Encl. Ref. column in table below for enclosure reference:

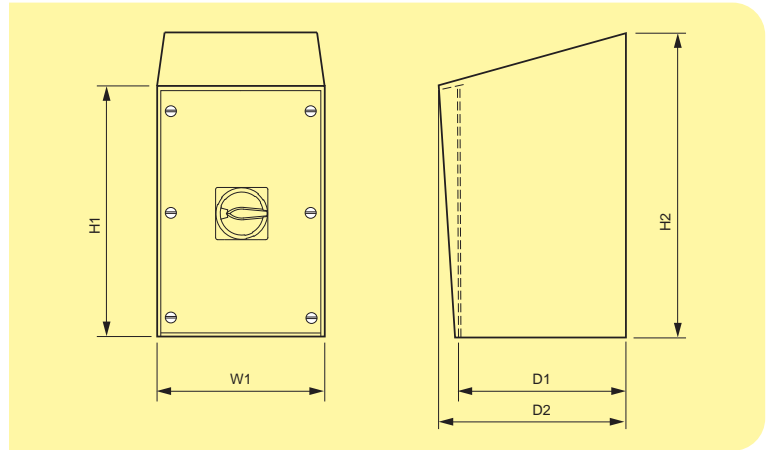

4 Pole (3ph + Sw N <sup>1</sup> ) +2 N.O. Aux	Article No.	le / AC-21A
KG20.T204/GBA650.*SR04	70068098	25A
KG32.T204/GBA650.*SR04	70068102	32A
KG20.T204/GBA602.*SR14	70068106	25A <sup>2)</sup>
KG32.T204/GBA602.*SR14	70068107	32A <sup>2)</sup>
KG41.T204/GBA602.*SR14	70068109	40A
KG64.T204/GBA602.*SR14	70068114	63A
KG80.T204/GBA602.*SR24	70068116	80A
KG100.T204/GBA602.*SR24	70068118	100A
KG105.T204/GBA602.*SR24	70068119	125A

**Note** 1) Switched neutral pole is early make/late break.  
2) Larger enclosure size (SR14)

## DIMENSIONS

Encl. Ref.	Front View			
	H1	W1	W2	W3
SR04L	171	130	155	180
SR14L	209	130	155	180
SR24L	299	185	210	260

Encl. Ref.	Side View		
	H2	D1	D2
SR04L	196	104.2	123.2
SR14L	234	133.2	152.2
SR24L	324	153.2	171.2

Please refer to the Encl. Ref. column in table below for enclosure reference:

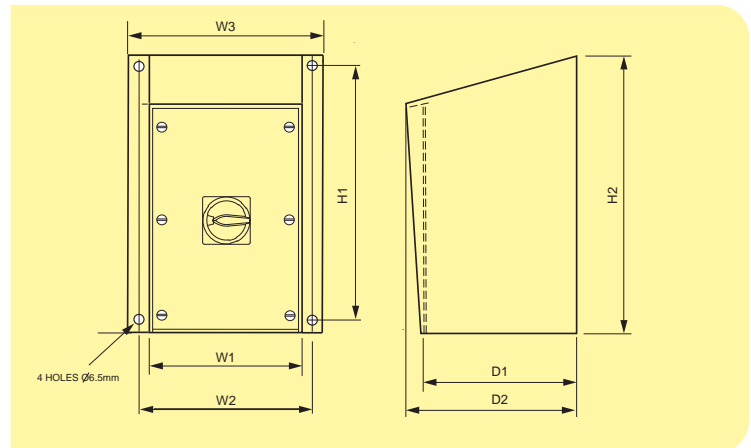

4 Pole (3ph + Sw N <sup>1</sup> ) +2 N.O. Aux	Article No.	le / AC-21A
KG20.T204/GBA680.*SR04L	70068293	25A
KG32.T204/GBA680.*SR04L	70068294	32A
KG20.T204/GBA602.*SR14L	70068299	25A <sup>2)</sup>
KG32.T204/GBA602.*SR14L	70068300	32A <sup>2)</sup>
KG41.T204/GBA602.*SR14L	70068302	40A
KG64.T204/GBA602.*SR14L	70068304	63A
KG80.T204/GBA602.*SR24L	70068315	80A
KG100.T204/GBA602.*SR24L	70068322	100A
KG105.T204/GBA602.*SR24L	70068326	125A

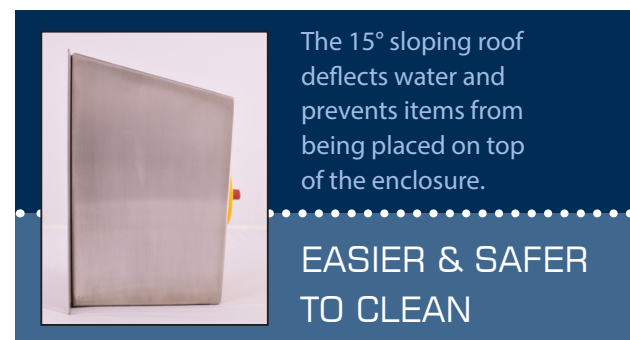

**Note** 1) Switched neutral pole is early make/late break.  
2) Larger enclosure size (SR14L)



# Main/emergency-off switch 25A - 315A

3, 4 & 6 POLE



**IP & IK RATING** IP66 + IK10 protection

**ENCLOSURE** GRP, grey RAL7035

**HANDLE OPTION** red & yellow padlockable handle  
optional black handle available

**EARTH TERMINAL** included

**SAFETY FEATURE** switch is interlocked with the lid to prevent opening in 'ON' position

WITHOUT AUXILIARIES

le / AC-21A	AC-23A	3 Pole	Article No.	3 Pole + Solid Neutral (TP&N)	Article No.
25A	7.5kW	KG20.T203/GB00U2.*GP1	70063164	KG20.T207/GB00U2.*GP1	70063856
32A	11kW	KG32.T203/GB00U2.*GP1	70063165	KG32.T207/GB00U2.*GP1	70080274
40A	15kW	KG41.T203/GB00U2.*GP1	70063258	KG41.T207/GB00U2.*GP1	70075142
63A	22kW	KG64.T203/GB00U2.*GP1	70063268	KG64.T207/GB00U2.*GP1	70080275
80A	30kW	KG80.T203/GB00U2.*GP1	70063731	KG80.T207/GB00U2.*GP1	70075143
100A	37kW	KG100.T203/GB00U2.*GP1	70069955	KG100.T207/GB00U2.*GP1	70080277
125A	30kW	KG105.T203/GB00U2.*GP1	70075140	KG105.T207/GB00U2.*GP1	70075145
125A <sup>3)</sup>	45kW	KG125.T203/GB00T2.*GP6	70063337	KG125.T207/GB00T2.*GP6	70063863
160A	55kW	KG160.T203/GB00T2.*GP6	70063339	KG160.T207/GB00T2.*GP6	70063864
200A	75kW	KG210.T203/GB00T1.*GP6	70063343	KG210.T207/GB00T1.*GP6	70063865
250A	90kW	KG250.T203/GB00T1.*GP6	70063344	KG250.T207/GB00T1.*GP6	70063868
315A	110kW	KG315.T203/GB00T1.*GP6	70063345	KG315.T207/GB00T1.*GP6	70063869

WITH AUXILIARIES <sup>1</sup>

le / AC-21A	AC-23A	3 Pole + Aux	Article No.	3 Pole + Solid Neutral (TP&N) + Aux	Article No.
25A	7.5kW	KG20.T203/GB20U2.*GP1	70063346	KG20.T207/GB20U2.*GP1.	70063870
32A	11kW	KG32.T203/GB20U2.*GP1	70073572	KG32.T207/GB20U2.*GP1	70063871
40A	15kW	KG41.T203/GB20U2.*GP1	70069680	KG41.T207/GB20U2.*GP1	70075183
63A	22kW	KG64.T203/GB20U2.*GP1	70075179	KG64.T207/GB20U2.*GP1	70075184
80A	30kW	KG80.T203/GB20U2.*GP1	70075180	KG80.T207/GB20U2.*GP1	70075185
100A	37kW	KG100.T203/GB20U2.*GP1	70077449	KG100.T207/GB20U2.*GP1	70075225
125A	30kW	KG105.T203/GB20U2.*GP1	70075181	KG105.T207/GB20U2.*GP1	70063876
125A <sup>3)</sup>	45kW	KG125.T203/GB22T2.*GP6	70063384	KG125.T207/GB22T2.*GP6	70063953
160A	55kW	KG160.T203/GB22T2.*GP6	70063385	KG160.T207/GB22T2.*GP6	70063954
200A	75kW	KG210.T203/GB22T1.*GP6	70063386	KG210.T207/GB22T1.*GP6	70063958
250A	90kW	KG250.T203/GB22T1.*GP6	70063387	KG250.T207/GB22T1.*GP6	70063961
315A	110kW	KG315.T203/GB22T1.*GP6	70063388	KG315.T207/GB22T1.*GP6	70063963



## OPTIONS CAN INCLUDE :

- terminal blocks
- lid mounted push buttons & pilot lights
- emergency stop push button
- lockable door
- defeatable door interlock



## DIMENSIONS

Encl. Ref.	A	B	C	D	E	F	G
GP1	300	265	165	222	316	354	184
GP3	425	325	180	348	377	480	245
GP6	500	430	210	423	485	555	353
GP23	650	540	260	573	594	705	462
GP27	805	615	315	723	665	855	533

Please refer to end of part no. for enclosure reference.  
See tables below:

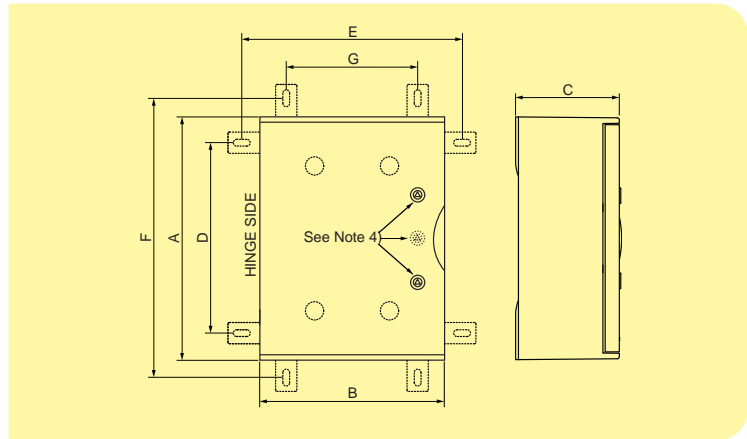

4 Pole (3ph + Sw N <sup>2</sup> )		Article No.	6 Pole		Article No.	le / AC-21A
	KG20.T204/GB00U2.*GP1	70063407		KG20B.T206/GB00U2.*GP1	70075161	25A
	KG32.T204/GB00U2.*GP1	70063410		KG32B.T206/GB00U2.*GP1	70075163	32A
	KG41.T204/GB00U2.*GP1	70075147		KG41B.T206/GB00U2.*GP1	70075164	40A
	KG64.T204/GB00U2.*GP1	70075148		KG64B.T206/GB00U2.*GP1	70075166	63A
	KG80.T204/GB00U2.*GP1	70075157		KG80.T206/GB00U2.*GP3	70073757	80A
	KG100.T204/GB00U2.*GP1	70069957		KG100.T206/GB00U2.*GP3	70073535	100A
	KG105.T204/GB00U2.*GP1	70075159		KG105.T206/GB00U2.*GP3	70075170	125A
	KG125.T204/GB00T2.*GP6	70063426		KG125.T206/GB00T2.*GP6	70063526	125A <sup>3)</sup>
	KG160.T204/GB00T2.*GP6	70063473		KG160.T206/GB00T2.*GP6	70063528	160A
	KG210.T204/GB00T1.*GP6	70063479		C200-4.T206/GB00T1.*GP23	70063530	200A
	KG250.T204/GB00T1.*GP6	70063481				250A
	KG315.T204/GB00T1.*GP6	70063486		C316.T206/GB00T1.*GP27	70063531	315A

4 Pole (3ph + Sw N <sup>2</sup> ) + Aux		Article No.	6 Pole + Aux		Article No.	le / AC-21A
	KG20.T204/GB20U2.*GP1	70063504		KG20B.T206/GB20U2.*GP1	70063546	25A
	KG32.T204/GB20U2.*GP1	70063505		KG32B.T206/GB20U2.*GP1	70073559	32A
	KG41.T204/GB20U2.*GP1	70075227		KG41B.T206/GB20U2.*GP1	70063550	40A
	KG64.T204/GB20U2.*GP1	70075230		KG64B.T206/GB20U2.*GP1	70063551	63A
	KG80.T204/GB20U2.*GP1	70075239		KG80.T206/GB20U2.*GP3	70073752	80A
	KG100.T204/GB20U2.*GP1	70072836		KG100.T206/GB20U2.*GP3	70073570	100A
	KG105.T204/GB20U2.*GP1	70075243		KG105.T206/GB20U2.*GP3	70075246	125A
	KG125.T204/GB22T2.*GP6	70063512		KG125.T206/GB22T2.*GP6	70063557	125A <sup>3)</sup>
	KG160.T204/GB22T2.*GP6	70063514		KG160.T206/GB22T2.*GP6	70063558	160A
	KG210.T204/GB22T1.*GP6	70063516		C200-4.T206/GB22T1.*GP23	70063559	200A
	KG250.T204/GB22T1.*GP6	70063517				250A
	KG315.T204/GB22T1.*GP6	70063518		C316.T206/GB22T1.*GP27	70068331	315A

### Notes

- The following auxiliary contacts are provided:-
 

KG20 to KG105	2 N.O. (early break)
KG125 to KG315	2 N.O. (early break) + 2 N.C.
C200-4 & C316	2 N.O. (early break)
- Switched neutral pole is early make/late break.
- KG125 suitable for applications requiring larger cable termination and increased enclosure size.
- GP1 enclosures have 1 quarter turn lock. GP3, GP6, GP23 & GP27 enclosures have 2 quarter turn locks.



# Main/emergency-off switch 25A - 315A

3, 4 & 6 POLE



- IP& IK RATING** IP66 + IK10 protection
- ENCLOSURE** GRP, grey (RAL7035) or red (RAL3000)
- HANDLE OPTION** red & yellow padlockable handle optional black handle available
- EARTH TERMINAL** included
- FEATURE** key lockable hinged lid, with interlock to prevent opening in the "ON" position

## COMBINE A NUMBER OF DIFFERENT SWITCHES & DEVICES IN ONE ENCLOSURE

Kraus & Naimer offer a standard range of rotary isolators and changeover switches in GRP enclosures ranging from 25A to 315A, from 3 - 6 Pole and can also offer a variety of different fitted options from stock.

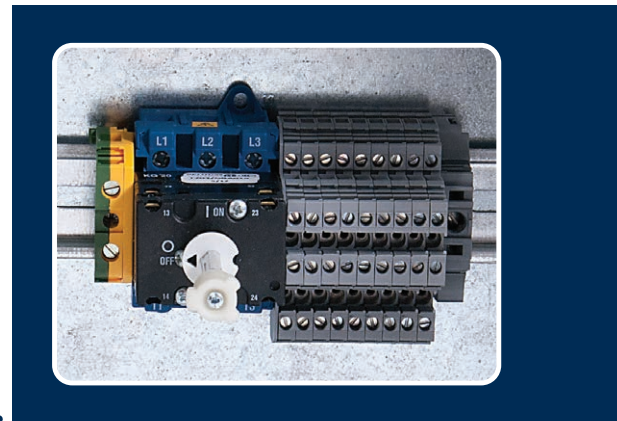

# Main/emergency-off switch 20A - 315A

3, & 6 POLE



- FEATURES** interlocked lid
- integral metal plate to maintain cable screen continuity between input and output cables.
- Screen termination by spring clamp (KG10-KG100) or screw clamp (KG125 - KG315).
- Connections for screened control cables also available

- IP RATING** IP66/67 protection
- ENCLOSURE** grey insulated
- HANDLE OPTION** red and yellow padlockable handle optional black handle available

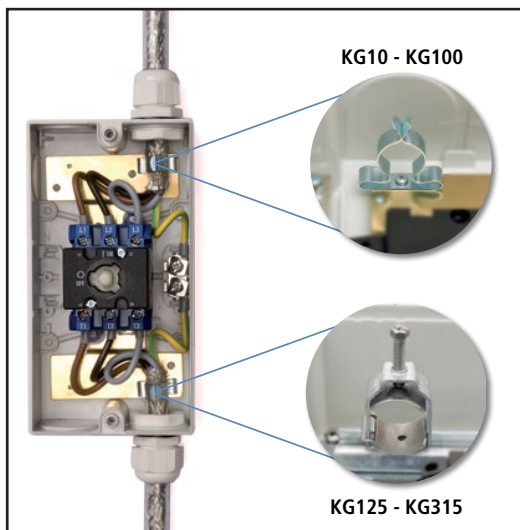

Screen Cable Dimensions (mm)	
KG10	8 - 11
KG20, KG32, KG20B, KG32B	11 - 17
KG41, KG64	11 - 17
KG41B, KG64B	22 - 30
KG80, KG100	22 - 30
KG80C, KG100C	28 - 34
KG125 - KG250	34 - 40
KG315	46 - 52





## ALL IN ONE SOLUTION

Combine a number of different switches/devices in one enclosure.

- Faster & safer installation
- Maximum flexibility
- Cost effective



Please contact us to discuss your exact requirements. Our team are highly trained and ready to help with any technical questions you may have.

## INSULATED enclosure



EMC compliant connection

## DIMENSIONS

Encl. Ref.	Encl. Dim.			Encl. Dim.			Line Drg.
	H	W	D	H1	W1	d	
KS51V	120	85	90	110	-	4.2	Fig. 1
KL51V	160	85	82	150	-	5.6	Fig. 1
KL11V	190	100	93	178	-	5.6	Fig. 1
KL71V	250	145	107	229	124	6.5	Fig. 2
STM3 (3 Pole)	560	280	180	534	254	7	Fig. 2
STM6 (6 Pole)	560	380	180	534	354	7	Fig. 2

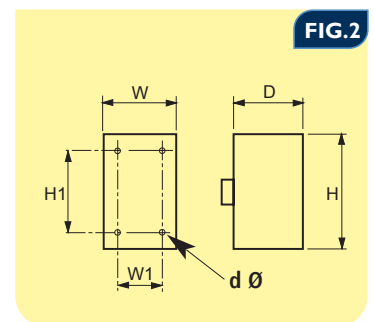
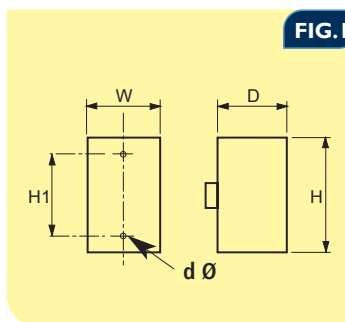

Please refer to the Encl. Ref. column in table below for enclosure reference:

le / AC-21A	AC-23A	3 Pole + 1 n/o + 1 n/c Aux	Article No.	Encl. Ref	6 Pole + 1 n/o + 1 n/c Aux	Article No.	Encl. Ref
20A	5.5kW	KG10.T203/D-A076.KS51V	70008610	KS51V			
25A	7.5kW	KG20.T203/D-A159.KL51V	70011109	KL51V	KG20B.T206/D-A059.KL11V	70011049	KL11V
32A	11kW	KG32.T203/D-A117.KL51V	70010424	KL51V	KG32B.T206/D-A054.KL11V	70011051	KL11V
40A	15kW	KG41.T203/D-A145.KL11V	70011035	KL11V	KG41B.T206/D-A052.KL11V	70029381	KL71V
63A	22kW	KG64.T203/D-A173.KL11V	70010412	KL11V	KG64B.T206/D-A066.KL11V	70019521	KL71V
80A	30kW	KG80.T203/D-A108.KL71V	70010474	KL71V	KG80C.T206/D-A070.STM	70022583	STM6
100A	37kW	KG100.T203/D-A120.KL71V	70011306	KL71V	KG100C.T206/D-A060.STM	70022584	STM6
125A	45kW	KG125.T203/D-A082.STM	70021607	STM3	KG125.T206/D-A020.STM	70022585	STM6
160A	55kW	KG160.T203/D-A077.STM	70011325	STM3	KG160.T206/D-A040.STM	70022587	STM6
250A	90kW	KG250.T203/D-A075.STM	70015149	STM3			
315A	110kW	KG315.T203/D-A034.STM	70010413	STM3			



# AC Switch disconnectors 25 - 40A

single & three phase  
AC-21A



- IP RATING** IP66/67 protection
- ENCLOSURE** grey insulated (RAL7035)
- HANDLE OPTION** red/yellow padlockable handle, optional black/grey available
- EARTH TERMINAL** included
- FEATURE** switch interlocked with lid to prevent opening in 'ON' position

## AC Switch Disconnectors - for Single Phase

SINGLE PHASE

Current Rating AC-21A (per contact)	Order Code No.	Article No.	FIG.
25A	KG20.T203/GBA270.*KS1V	70053688	FIG 4
25A	KG20.T203/GBA294.*KL <sup>1)</sup>	70028990	FIG 1
32A	KG32.T203/GBA294.*KL <sup>1)</sup>	70055409	FIG 1
40A	KG41.T203/GBA270.*KL1V	70028993	FIG 2

## AC Switch Disconnectors - for Three Phase (3ph + Sw N<sup>2)</sup>)

THREE PHASE

Current Rating AC-21A (per contact)	Order Code No.	Article No.	FIG.
25A	KG20.T204/GBA290.*KS1V	70029049	FIG 4
25A	KG20.T204/GBA486.KL51V <sup>1)</sup>	70028991	FIG 1
32A	KG32.T204/GBA486.KL51V <sup>1)</sup>	70028992	FIG 1
40A	KG41.T204/GBA290.*KL1V	70036915	FIG 2

<sup>1)</sup> Larger enclosure to match KG20/32 T104 DC enclosure  
<sup>2)</sup> Switched neutral pole is early make / late break.

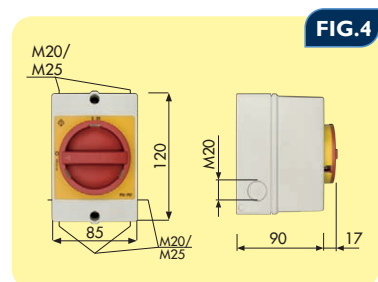
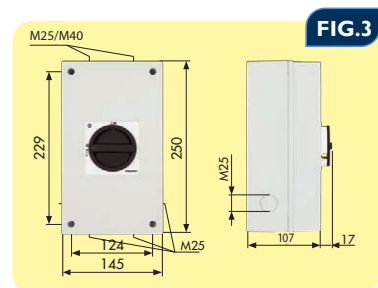
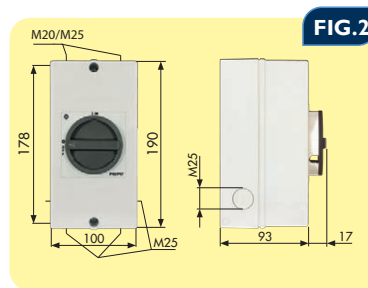
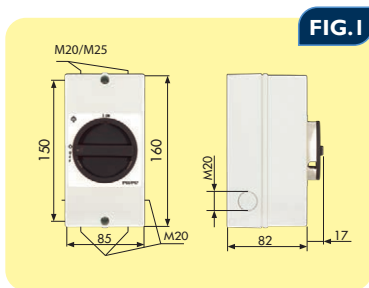

A simple change to the T ref. within the part no. for handle options

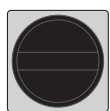

= .. T104 ..  
= .. T103 ..

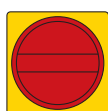

= .. T204 ..  
= .. T203 ..

up to 50A @ 220 -1000V

# DC Switch disconnectors

**IP RATING** IP66/67 protection

**ENCLOSURE** grey insulated (RAL7035)

**HANDLE OPTION** black/grey padlockable handle, with option for red/yellow handle

**FEATURES** switch is interlocked with the lid to

prevent opening in 'ON' position

class II compliant

rated for use in ambient temperatures up to 50°C

non-polarity sensitive

KG40 - up to 50 amps @1000 VDC to give higher rating achieved by use of permanent magnets in the contact body used to reduce arcing time



single & two string  
DC-21B

## Single String DC Switch Disconnectors - Selection Chart DC-21B (DC-PV1)

Voltage													Order Code No.	Article No.	FIG.
250V	375V	400V	450V	500V	600V	650V	660V	750V	800V	850V	920V	1000V			
25A	25A	25A	25A	21A	20A	20A	18A	18A	18A	11A	11A		KG20.T104/D-P003.KL51V	70028988	FIG 1
					25A	25A	23A	23A	23A	15A	15A	12A	KG32.T104/D-P003.KL51V	70030919	FIG 1
50A	40A	40A	30A	30A									KGD40.TD102/D-P003.KL11V	70031025	FIG 2
	50A		40A	40A	40A	30A	30A	30A		20A	20A	20A	KGD40.TD103/D-P003.KL11V	70031026	FIG 2
		50A	50A	50A		40A	40A	40A	40A	30A	30A	30A	KGD40.TD104/D-P003.KL11V	70031028	FIG 2
					50A	50A	50A	50A		40A	40A	40A	KGD40B.TD106/D-P003.KL11V	70031029	FIG 3
									50A	50A	50A	50A	KGD40B.TD108/D-P003.KL11V	70031031	FIG 3

SINGLE STRING

## Two String DC Switch Disconnectors - Selection Chart DC-21B (DC-PV1)

Ratings Per String (220V - 500V)											Order Code No.	Article No.	FIG.
220V	250V	280V	330V	340V	375V	400V	420V	440V	460V	500V			
25A	21A	21A	20A	20A	18A	18A	11A	11A	11A		KG20.T104/GB-P103.KL51V	70028989	FIG 1
28A	28A	28A	25A	25A	23A	23A	15A	15A	15A	12A	KG32.T104/GB-P103.KL51V	70030920	FIG 1
50A	50A	40A	40A	40A	40A	40A	30A	30A	30A	30A	KGD40.TD104/D-P004.KL11V	70031027	FIG 2
		50A	50A	50A	50A		40A	40A	40A	40A	KGD40B.TD106/D-P004.KL11V	70031030	FIG 3
						50A	50A	50A	50A	50A	KGD40B.TD108/D-P004.KL11V	70031032	FIG 3
Ratings Per String (510V - 1000V)											Order Code No.	Article No.	FIG.
510V	560V	600V	660V	680V	690V	750V	800V	920V	1000V				
20A	20A	20A	20A	12A	12A	12A	12A	8A	8A		KGD40.TD104/D-P004.KL11V	70031027	FIG 2
25A	23A	23A		15A	15A						KG32B.T106/GB-P103.KL11V	70030795	FIG 2
				20A	18A	18A	18A	11A			KG20B.T108/GB-P103.KL11V	70068395	FIG 3
40A	40A	40A	30A	30A	30A	30A	20A	20A	20A		KGD40B.TD106/D-P004.KL11V	70031030	FIG 3
			40A	40A	40A	40A	40A	30A	30A		KGD40B.TD108/D-P004.KL11V	70031032	FIG 3

TWO STRING

TWO STRING

Please select the switch disconnecter according to the maximum voltage and current output of all upstream PV modules, this must include all corrective factors according to relevant standards. DC-PV2 ratings available on request.



# Changeover switch with centre off

## 16A - 160A

2, 3 & 4 POLE



### INSULATED

- IP66/67 protection
- auxiliary contacts provided with 3 & 4 pole switches
- black & red handle, padlockable in 'OFF' position
- earth terminal
- grey insulated enclosed (RAL7035)
- switch interlocked with lid to prevent opening in 'ON' position

ie / AC-21A	2 Pole	Article No.	Encl. Ref
16A	KH16.T902/GBA002.*KS52	70055494	KSA
20A	KH20.T902/GBA002.*KS52	70055486	KSA
25A	KH25.T902/GBA002.*KS52	70031001	KSA
32A	KH32.T902/GBA002.*KL12	70055196	KLC
40A	KH40.T902/GBA002.*KL12	70054174	KLC
63A	KH63.T902/GBA002.*KL72	70053809	KLE
80A	KH80.T902/GBA002.*KL72	70055506	KLE
100A	KH85.T902/GBA012.*KL72	70054210	KLE
125A			
125A <sup>3)</sup>			
160A			

2, 3 & 4 POLE



### MILD STEEL

- IP66 protection
- auxiliary contacts provided with 3 & 4 pole switches
- black & red handle, padlockable in 'OFF' position
- earth terminal & lid bonding link included
- grey powder paint finish (RAL7032) also available in red powder paint finish (RAL3000)
- switch interlocked with lid to prevent opening in 'ON' position

ie / AC-21A	2 Pole	Article No.	Encl. Ref
16A	KH16.T902/GBA020.*MB2	70063562	MB2
20A	KH20.T902/GBA020.*MB2	70063565	MB2
25A	KH25.T902/GBA020.*MB2	70063564	MB2
32A	KH32.T902/GBA020.*MB2	70063567	MB2
40A	KH40.T902/GBA020.*MB2	70063568	MB2
63A	KH63.T902/GBA020.*MB3	70063569	MB3
80A	KH80.T902/GBA020.*MB3	70063570	MB3
100A	KH85.T902/GBA020.*MB3	70063572	MB3
125A			
125A <sup>3)</sup>			
160A			

2, 3 & 4 POLE



### STAINLESS STEEL

- IP66 protection
- auxiliary contacts provided with 3 & 4 pole switches
- black & red handle, padlockable in 'OFF' position
- earth terminal & lid bonding link included
- stainless steel enclosure, grade 316L
- switch interlocked with lid to prevent opening in 'ON' position

ie / AC-21A	2 Pole	Article No.	Encl. Ref
16A	KH16.T902/GBA025.*SB2	70063592	SB2
20A	KH20.T902/GBA025.*SB2	70063593	SB2
25A	KH25.T902/GBA025.*SB2	70063594	SB2
32A	KH32.T902/GBA025.*SB2	70063596	SB2
40A	KH40.T902/GBA025.*SB2	70063598	SB2
63A	KH63.T902/GBA025.*SB3	70063599	SB3
80A	KH80.T902/GBA025.*SB3	70063601	SB3
100A	KH85.T902/GBA025.*SB3	70063603	SB3
125A			
125A <sup>3)</sup>			
160A			

**Notes**

1) 2-off electrically isolated early break auxiliary contacts are provided with the 3 & 4 pole switches. One of these contacts closes in position 1 and the other contact closes in position 2. Both of the contacts are open in the Off position.

2) Switched neutral pole is early make/late break.

3) KG125 suitable for applications requiring larger cable termination and increased enclosure size than the KG105.

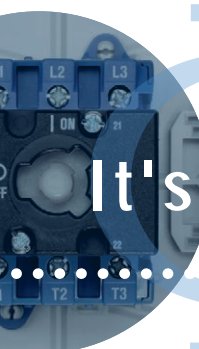

It's time for a changeover to Kraus & Naimer

# INSULATED, MILD & STAINLESS STEEL enclosure



## DIMENSIONS

3 Pole <sup>1)</sup>		Article No.	Encl. Ref	4 Pole (3ph+Sw N <sup>2)</sup> <sup>1)</sup>		Article No.	Encl. Ref
	KG20B.T903/GBA013.*KL	70054664	KLC		KG20B.T904/GBA014.*KL	70054624	KLD
	KG32B.T903/GBA013.*KL	70054593	KLC		KG32B.T904/GBA014.*KL	70054223	KLD
	KG41B.T903/GBA013.*KL	70054721	KLD		KG41B.T904/GBA004.*ST	70054691	ST2
	KG64B.T903/GBA013.*KL	70054594	KLD		KG64B.T904/GBA004.*ST	70054538	ST2
	KG80.T903/GBA013.*ST	70054643	STE		KG80.T904/GBA004.*ST	70054644	ST3
	KG100.T903/GBA013.*ST	70054647	STE		KG100.T904/GBA004.*ST	70055024	ST3
	KG105.T903/GBA013.*ST	70068347	STE		KG105.T904/GBA004.*ST	70054679	ST3
	KG125.T903/GBA035.*ST	70054713	ST4		KG125.T904/GBA045.*ST	70054714	ST4
	KG160.T903/GBA035.*ST	70055047	ST4		KG160.T904/GBA045.*ST	70068348	ST4

Encl. Ref.	Encl. Dim.				Encl. Dim.		
	H	W	D	D1	H1	W1	d
KSA	120	85	80	-	110	-	4.2
KLC	190	100	93	-	178	-	5.6
KLD	250	145	107	-	229	124	6.5
KLE	250	145	107	-	229	124	6.5
STE	280	190	180	-	254	164	7
ST2	280	190	130	-	254	164	7
ST3	380	280	180	-	354	254	7
ST4	560	380	180	-	534	354	7
MB2	194	119	115	-	133	137	6
MB3	254	149	125	8	193	167	6
MB4	309	234	150	8	248	252	6
MB9	500	400	175	-	440	340	6.5
SB2	194	119	116	-	133	137	6
SB3	254	149	126	-	193	167	6
SB4	309	234	151	-	248	252	6
SB9	500	400	175	-	440	340	6.5

3 Pole <sup>1)</sup>		Article No.	Encl. Ref	4 Pole (3ph+Sw N <sup>2)</sup> <sup>1)</sup>		Article No.	Encl. Ref
	KG20B.T903/GBA030.*MB3	70063574	MB3		KG20B.T904/GBA040.*MB3	70063583	MB3
	KG32B.T903/GBA030.*MB3	70063575	MB3		KG32B.T904/GBA040.*MB3	70063584	MB3
	KG41B.T903/GBA030.*MB3	70063658	MB3		KG41B.T904/GBA040.*MB3	70063586	MB3
	KG64B.T903/GBA030.*MB3	70063577	MB3		KG64B.T904/GBA040.*MB3	70063587	MB3
	KG80.T903/GBA030.*MB4	70063578	MB4		KG80.T904/GBA040.*MB4	70063588	MB4
	KG100.T903/GBA030.*MB4	70063579	MB4		KG100.T904/GBA040.*MB4	70063589	MB4
	KG105.T903/GBA030.*MB4	70063580	MB4		KG105.T904/GBA040.*MB4	70063665	MB4
	KG125.T903/GBA055.*MB9	70063581	MB9		KG125.T904/GBA065.*MB9	70063590	MB9
	KG160.T903/GBA055.*MB9	70063582	MB9		KG160.T904/GBA065.*MB9	70063591	MB9

Encl. Ref.	Cable Entries.	Line Drg.
KSA	4 x 20/25mm k'outs	Fig. 1
KLC	4 x 20/25mm k'outs	Fig. 1
KLD	4 x 25/40mm k'outs	Fig. 2
KLE	4 x 25/40mm k'outs	Fig. 2
STE	1 x gland plate	Fig. 2
ST2	2 x gland plates	Fig. 2
ST3	2 x gland plates	Fig. 2
ST4	2 x gland plates	Fig. 2
MB2	-	Fig. 3
MB3	-	Fig. 3
MB4	-	Fig. 3
MB9	2 x gland plates	Fig. 5
SB2	-	Fig. 4
SB3	-	Fig. 4
SB4	-	Fig. 4
SB9	2 x gland plates	Fig. 5

3 Pole <sup>1)</sup>		Article No.	Encl. Ref	4 Pole (3ph+Sw N <sup>2)</sup> <sup>1)</sup>		Article No.	Encl. Ref
	KG20B.T903/GBA050.*SB3	70063611	SB3		KG20B.T904/GBA060.*SB3	70063632	SB3
	KG32B.T903/GBA050.*SB3	70063617	SB3		KG32B.T904/GBA060.*SB3	70063633	SB3
	KG41B.T903/GBA050.*SB3	70063670	SB3		KG41B.T904/GBA060.*SB3	70063634	SB3
	KG64B.T903/GBA050.*SB3	70063619	SB3		KG64B.T904/GBA060.*SB3	70063635	SB3
	KG80.T903/GBA050.*SB4	70063625	SB4		KG80.T904/GBA060.*SB4	70063636	SB4
	KG100.T903/GBA050.*SB4	70063626	SB4		KG100.T904/GBA060.*SB4	70063637	SB4
	KG105.T903/GBA050.*SB4	70063627	SB4		KG105.T904/GBA060.*SB4	70063672	SB4
	KG125.T903/GBA075.*SB9	70063630	SB9		KG125.T904/GBA085.*SB9	70063638	SB9
	KG160.T903/GBA075.*SB9	70063631	SB9		KG160.T904/GBA085.*SB9	70063640	SB9

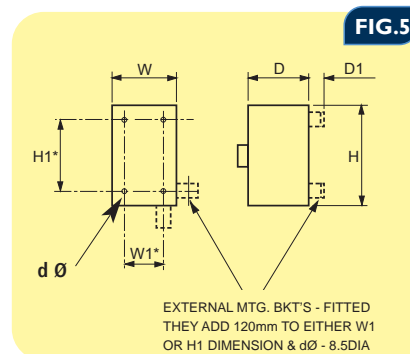
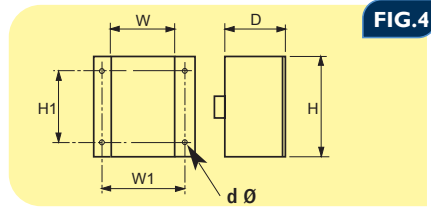
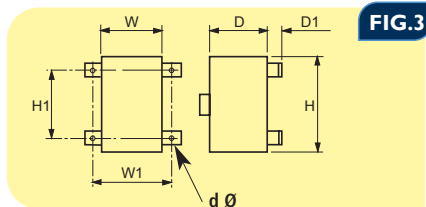
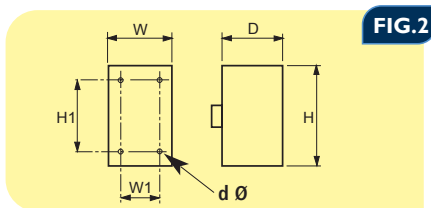
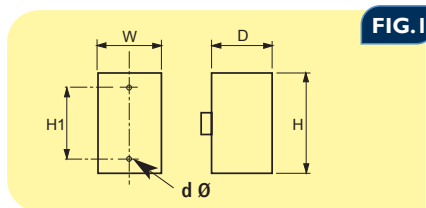



# Changeover switch with centre off

16A - 315A

2, 3 & 4 POLE



- IP& IK RATING** IP66 + IK10 protection
- ENCLOSURE** GRP, grey (RAL7035)
- HANDLE OPTION** black & red padlockable handle
- EARTH TERMINAL** included
- SAFETY FEATURE** switch is interlocked with the lid to prevent opening in 'ON' position

le / AC-21A	2 Pole	Article No.	3 Pole + Aux <sup>1</sup>	Article No.
16A	KH16.T902/GBCOT1.*GP2	70064871		
20A	KH20.T902/GBCOT1.*GP2	70064874		
25A	KH25.T902/GBCOT1.*GP2	70064875	KG20B.T903/GBC1U1.*GP1	70064883
32A	KH32.T902/GBCOT1.*GP2	70064876	KG32B.T903/GBC1U1.*GP1	70064884
40A	KH40.T902/GBCOT1.*GP2	70064877	KG41B.T903/GBC1U1.*GP1	70064885
63A	KH63.T902/GBCOT1.*GP2	70064879	KG64B.T903/GBC1U1.*GP1	70064887
80A	KH80.T902/GBCOT1.*GP2	70064881	KG80.T903/GBC1U1.*GP3	70064888
100A	KH85.T902/GBCOT1.*GP2	70064882	KG100.T903/GBC1U1.*GP3	70064889
125A			KG105.T903/GBC1U1.*GP3	70064890
125A <sup>3)</sup>			KG125.T903/GBC1T1.*GP6	70064891
160A			KG160.T903/GBC1T1.*GP6	70064893
200A			C200-4.T903/GBC1T1.*GP23	70064894
315A			C316.T903/GBC1T1.*GP27	70064895

# Load switch - changeover with centre off 32A - 315A

4 POLE



- IP RATING** IP66 protection
- ENCLOSURE** mild steel, grey powder paint finish RAL7032
- HANDLE OPTION** black and red padlockable handle

le / AC-21A	4 Pole	Order Code No.	Article No.	Encl. Ref.
32A	CA25.A213/GBA009.*MB20		70068388	MB20
40A	C32.A213/GBA009.*MB20		70068389	MB20
63A	C42.A213/GBA009.*MB20		70068390	MB20
100A	C80.A213/GBA009.*MB22		70071329	MB22
150A	C125.A213/GBA009.*MB22		70068392	MB22
200A	C200-4.A213/GBA002.*MB10		70068393	MB10
275A	C315.A213/GBA002.*MB10		70068394	MB10
315A	C315.A213/GBA010.*MB29		70068391	MB29

# GRP & PAINTED MILD STEEL enclosure



## DIMENSIONS

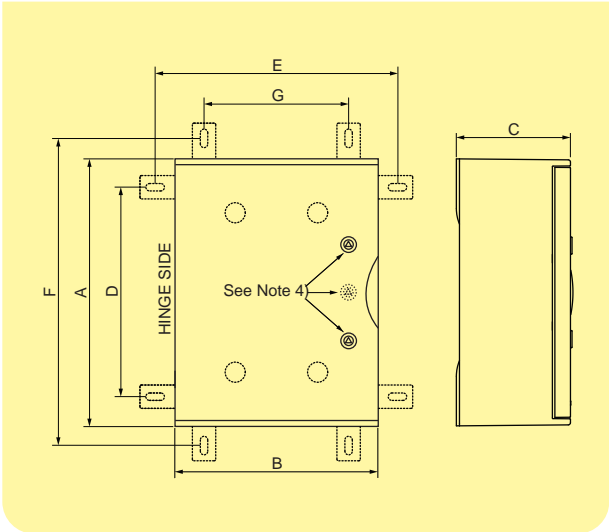

Encl. Ref.	A	B	C	D	E	F	G
GP1/GP2	300	265	165	222	316	354	184
GP3	425	325	180	348	377	480	245
GP6	500	430	210	423	485	555	353
GP23	650	540	260	573	594	705	462
GP27	805	615	315	723	665	855	533

Please refer to end of part no. for enclosure ref.

**OPTIONS CAN INCLUDE :**

- terminal blocks
- lid mounted push buttons & pilot lights
- emergency stop push button
- key lockable door handle

4 Pole (3ph + Sw N <sup>2</sup> ) + Aux <sup>1</sup>	Article No.	Ie / AC-21A
		16A
		20A
KG20B.T904/GBC1U1.*GP1	70064947	25A
KG32B.T904/GBC1U1.*GP1	70064948	32A
KG41B.T904/GBC1U1.*GP1	70064951	40A
KG64B.T904/GBC1U1.*GP1	70064952	63A
KG80.T904/GBC1U1.*GP3	70064955	80A
KG100.T904/GBC1U1.*GP3	70064957	100A
KG105.T904/GBC1U1.*GP3	70074816	125A
KG125.T904/GBC1T1.*GP6	70064965	125A <sup>3)</sup>
KG160.T904/GBC1T1.*GP6	70064968	160A
C200-4.T904/GBC1T1.*GP23	70064980	200A
C316.T904/GBC1T1.*GP27	70064981	315A

**Notes**

- 2-off electrically isolated early break auxiliary contacts are provided. One of these contacts closes in position 1 and the other contact closes in position 2. Both of the contacts are open in the OFF position.
- Switched neutral pole is early make/late break.
- KG125 suitable for applications requiring larger cable termination and increased enclosure size.
- GP1/GP2 enclosures have 1 quarter turn lock, GP3, GP6, GP23 & GP27 enclosures have 2 quarter turn locks.

# MILD STEEL enclosure



**EARTH TERMINAL** included + lid bonding link

**SAFETY FEATURE** switch is interlocked with the lid to prevent opening in 'ON' position

## DIMENSIONS

Encl. Ref.	Encl. Dim.				Encl. Dim.		
	H	W	D	D1	H1	W1	d
MB10	500	400	300	-	440	340	6.5
MB20	250	175	175	-	225	195	6
MB22	400	300	275	-	340	240	6.5
MB29	750	450	300	-	690	390	6.5

Encl. Ref.	Cable Entries.	Line Drg.
MB10	2 x gland plates	Fig.2
MB20	-	Fig.1
MB22	2 x gland plates	Fig.2
MB29	2 x gland plates	Fig.2

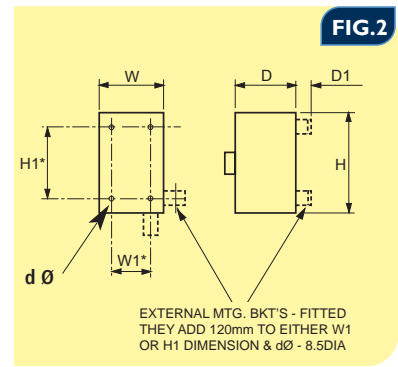
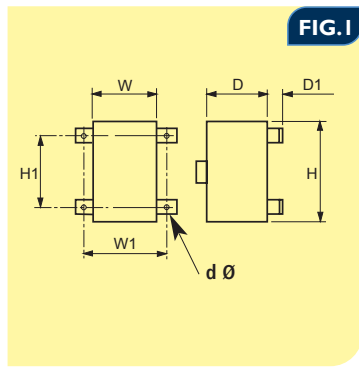

# Main/emergency-off switch

25A - 63A

stayput emergency-stop pushbutton, 1 N.C. contact, twist to reset.  
Switch interlocked with lid to prevent opening in 'ON' position higher ratings available on request

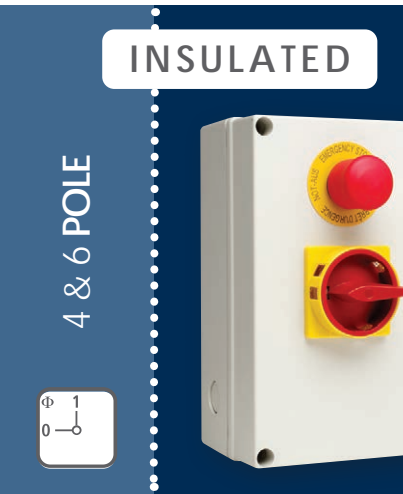

INSULATED

4 & 6 POLE

**IP RATING** IP66/67  
**ENCLOSURE** insulated, grey (RAL7035)  
**HANDLE OPTION** red/yellow padlockable handle  
**EARTH TERMINAL** included

le AC-21A	Order Code No.	Article No.	Encl.Ref.
<b>4 pole (3 ph+Sw N<sup>1</sup>) + 1 n.o. (early break) + 1 n.c. Aux</b>			
25A	KG20.T204/GBA285.*KL	70055051	KLD
32A	KG32.T204/GBA285.*KL	70055090	KLD
40A	KG41.T204/GBA285.*KL	70054040	KLD
63A	KG64.T204/GBA285.*KL	70054194	KLD
80A	KG80.T204/GBA285.*KL	70068336	KLD
100A	KG100.T204/GBA285.*KL	70055023	KLD
<b>6 pole + 1 n.o. (early break) + 1 n.c. Aux</b>			
25A	KG20B.T206/GBA095.*KL	70054557	KLD
32A	KG32B.T206/GBA095.*KL	70054686	KLD
40A	KG41B.T206/GBA095.*KL	70054689	KLD
63A	KG64B.T206/GBA095.*KL	70068337	KLD

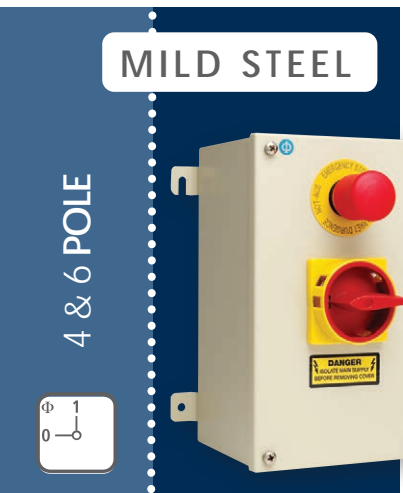

MILD STEEL

4 & 6 POLE

**IP RATING** IP66  
**ENCLOSURE** grey powder paint finish (RAL7032) also available in red paint finish (RAL3000)  
**HANDLE OPTION** red/yellow padlockable  
**EARTH TERMINAL** included + lid bonding link

le AC-21A	Order Code No.	Article No.	Encl.Ref.
<b>4 pole (3 ph+Sw N<sup>1</sup>) + 1 n.o. (early break) + 1 n.c. Aux</b>			
25A	KG20.T204/GBA350.*MB3E	70063645	MB3E
32A	KG32.T204/GBA350.*MB3E	70063646	MB3E
40A	KG41.T204/GBA350.*MB3E	70063647	MB3E
63A	KG64.T204/GBA350.*MB3E	70063674	MB3E
80A	KG80.T204/GBA350.*MB3E	70063676	MB3E
100A	KG100.T204/GBA350.*MB3E	70063677	MB3E
<b>6 pole + 1 n.o. (early break) + 1 n.c. Aux</b>			
25A	KG20B.T206/GBA155.*MB3E	70063680	MB3E
32A	KG32B.T206/GBA155.*MB3E	70063682	MB3E
40A	KG41B.T206/GBA155.*MB3E	70063684	MB3E
63A	KG64B.T206/GBA155.*MB3E	70063686	MB3E

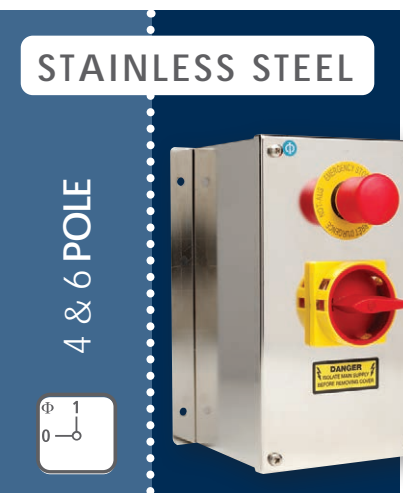

STAINLESS STEEL

4 & 6 POLE

**IP RATING** IP66  
**ENCLOSURE** stainless steel, grade 316L  
**HANDLE OPTION** red/yellow padlockable  
**EARTH TERMINAL** included + lid bonding link

le AC-21A	Order Code No.	Article No.	Encl.Ref.
<b>4 pole (3 ph+Sw N<sup>1</sup>) + 1 n.o. (early break) + 1 n.c. Aux</b>			
25A	KG20.T204/GBA440.*SB3E	70063690	SB3E
32A	KG32.T204/GBA440.*SB3E	70063695	SB3E
40A	KG41.T204/GBA440.*SB3E	70063698	SB3E
63A	KG64.T204/GBA440.*SB3E	70063699	SB3E
80A	KG80.T204/GBA440.*SB3E	70063702	SB3E
100A	KG100.T204/GBA440.*SB3E	70063703	SB3E
<b>6 pole + 1 n.o. (early break) + 1 n.c. Aux</b>			
25A	KG20B.T206/GBA555.*SB3E	70063704	SB3E
32A	KG32B.T206/GBA555.*SB3E	70063705	SB3E
40A	KG41B.T206/GBA555.*SB3E	70063706	SB3E
63A	KG64B.T206/GBA555.*SB3E	70063707	SB3E

## DIMENSIONS

Encl. Ref.	Encl. Dim.				Encl. Dim.			Cable Entries.	Line Drg.
	H	W	D	D1	H1	W1	d		
KLD	250	145	107	-	229	124	6.5	4 x 25/40mm kouts	Fig. 1
MB3E	254	149	125	8	193	167	6	-	Fig. 2
SB3E	254	149	126.5	-	193	167	6	-	Fig. 3

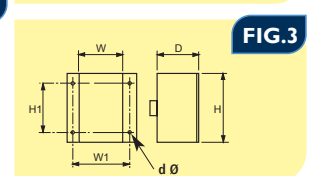
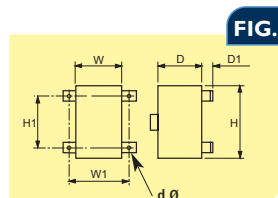
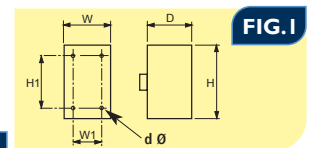



# 32A - 125A Mains-off-generator with appliance inlet



**IP RATING** IP66 protection

**ENCLOSURE** mild steel, grey paint finish (RAL7035)

**MILD STEEL enclosure**

**HANDLE OPTION** black & red padlockable handle, padlockable in OFF position only (other options on request)

**EARTH TERMINAL** included

**SAFETY FEATURE** switch is interlocked with the lid to prevent opening in the 'ON' positions

**APPLIANCE INLET** Available on either the right or left side of the enclosure. IP67 rated with locking ring. Socket is pre-wired to the switch.

## DIMENSIONS

Encl. Ref.	A	B	C	D	E	K
1	300	200	150	160	260	327
2	300	200	150	160	260	355
3	400	300	200	260	360	455
4	400	300	200	260	360	430

**Note**

2-off electrically isolated early break auxiliary contacts are provided with the 4 pole switches. One of these contacts closes in position 1 and the other contact closes in position 2. Both of the contacts are open in the Off position.

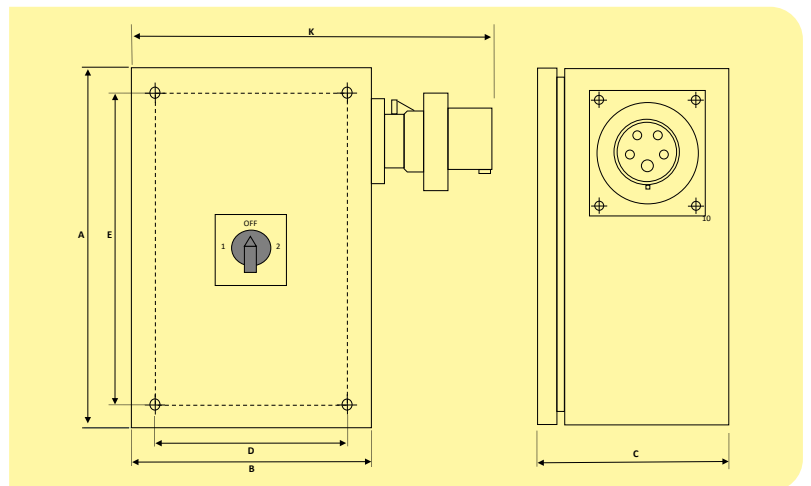

le AC-21A	Left side inlet 2 Pole - 3 Pin	Article No.	Encl. Ref	Left side inlet 4 Pole - 5 Pin + Aux	Article No.	Encl. Ref
32A	KH32.T902/GBL3P00.EB231	70080430	1	KG32B.T904/GBL5P20.EB231	70080444	1
63A	KH63.T902/GBL3P00.EB231	70080427	2	KG64B.T904/GBL5P20.EB342	70080434	3
125A				KG105.T904/GBL5P20.EB342	70080431	4
le AC-21A	Right side inlet 2 Pole - 3 Pin	Article No.	Encl. Ref	Right side inlet 4 Pole - 5 Pin + Aux	Article No.	Encl. Ref
32A	KH32.T902/GBR3P00.EB231	70080428	1	KG32B.T904/GBR5P20.EB231	70080442	1
63A	KH63.T902/GBR3P00.EB231	70080426	2	KG64B.T904/GBR5P20.EB342	70080433	3
125A				KG105.T904/GBR5P20.EB342	70077843	4

# Emergency stop pushbutton station



**twist to reset** - 38mm diameter red mushroom head - 1 N.C. contact. Complies with EN 418/EN 60204-1.

without protective shroud					
	<b>Order Code No.</b>	PSN-GB0001	PN261/GBA005.*SF1A	PN091/GBA023.*SB31	PN091/GBA017.*MB31
	<b>Article No.</b>	2169016	2337513	2336638	2337159
	<b>Encl.Ref.</b>	<b>P1Y</b>	<b>SF1A</b>	<b>SB31</b>	<b>MB31</b>
	<b>Features</b>	insulated enclosure IP66/67/69K	flush mounted stainless steel 316L IP40 (IP65 achievable with sealant) galvanised back box earth stud included	surface mounted stainless steel 316L IP66 earth terminal & lid bonding link	surface mounted Grey RAL7032 mild steel IP66 earth terminal & lid bonding link

**key operate to reset (1 included)** 38mm diameter red mushroom head - Complies with EN 418/EN 60204-1.

without protective shroud					
	<b>Order Code No.</b>	PSN-GB0003	PN261/GBA007.*SF1A	PN091/GBA024.*SB31	PN091/GBA019.*MB31
	<b>Article No.</b>	2169018	2337515	2337516	2337517
	<b>Encl.Ref.</b>	<b>P1Y</b>	<b>SF1A</b>	<b>SB31</b>	<b>MB31</b>
	<b>Features</b>	insulated enclosure IP66/67/69K	flush mounted stainless steel 316L IP40 (IP65 achievable with sealant) galvanised back box earth stud included	surface mounted stainless steel 316L IP66 earth terminal & lid bonding link	surface mounted Grey RAL7032 mild steel IP66 earth terminal & lid bonding link

## DIMENSIONS for all Pushbutton Stations on this page

Encl. Ref.	Front Plate			H1	W1	D	Cable Entries.	Line Drg.
	H	W	D					
P1Y	80	72	56	66.5	58.5	4.5	1 x 20mm + 2 x20/25mm k'outs	Fig. 1
SF1A	100	100	2	78	78	52	8 x 20mm k'outs	Fig. 3
SB31	100	100	60	120	70	6.5	-	Fig. 2
MB31	100	100	60	120	70	6.5	-	Fig. 2

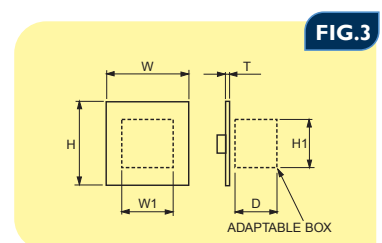
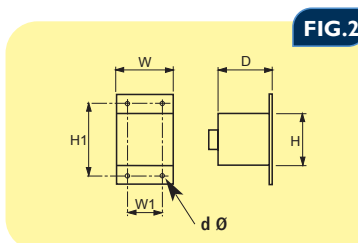
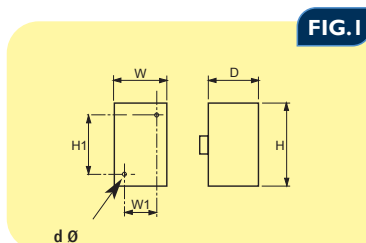

# INSULATED, MILD & STAINLESS STEEL enclosure

**twist to reset** - 38mm diameter red mushroom head - 1 N.C. contact. Complies with EN 418/EN 60204-1.

				with protective shroud
PSN-GB0053	PN261/GBA010.*SF1A	PN091/GBA025.*SB31	PN091/GBA021.*MB31	<b>Order Code No.</b>
2169036	2337518	2337520	2337521	<b>Article No.</b>
<b>P1Y</b>	<b>SF1A</b>	<b>SB31</b>	<b>MB31</b>	<b>Encl.Ref.</b>
insulated enclosure IP66/67	flush mounted stainless steel 316L IP40 (IP65 achievable with sealant) galvanised back box earth stud included	surface mounted stainless steel 316L IP66 earth terminal & lid bonding link	surface mounted Grey RAL7032 mild steel IP66 earth terminal & lid bonding link	<b>Features</b>

**key operate to reset (1 included)** 38mm diameter red mushroom head - Complies with EN 418/EN 60204-1.

				with protective shroud
PSN-GB0054	PN261/GBA011.*SF1A	PN091/GBA026.*SB31	PN091/GBA023.*MB31	<b>Order Code No.</b>
2336281	2337522	2337524	2337525	<b>Article No.</b>
<b>P1Y</b>	<b>SF1A</b>	<b>SB31</b>	<b>MB31</b>	<b>Encl.Ref.</b>
insulated enclosure IP66/67	flush mounted stainless steel 316L IP40 (IP65 achievable with sealant) galvanised back box earth stud included	surface mounted stainless steel 316L IP66 earth terminal & lid bonding link	surface mounted Grey RAL7032 mild steel IP66 earth terminal & lid bonding link	<b>Features</b>

## Fire alarm isolator double pole 10A

Complies with EN BS5839 Part 1:2013, marked with the symbol for on-load isolation according to BS7671:2008

Providing a secure method of safely isolating the mains power supply to CIE during maintenance periods.

The double pole device provides isolation of both the live and neutral supply and can only be operated by authorised maintenance technicians



**FEATURE** key removable in both positions





supplied with 2 keys

Ie AC-21A	2 Pole	Article No.	
10A	CA4.T302/GBA001.RPB1	70075317	

## Rotary Control switch

Grey Enclosure IP65









			Order Code No.	Article No.	Encl. Ref.
Off-On	1 pole		GB2.KN1	70068989	PF1A
Off-On	3 pole		GB2.KN3	70068991	PF1B
Changeover, without Off	1 pole		GB2.KN2	70063125	PF1A
Changeover, with Off	2 pole		GB2.KN10	70068992	PF1B

## Key Operated Control switch

Grey Enclosure IP40



			Order Code No.	Article No.	Encl. Ref.	Price (£)
Off-On <sup>1)</sup>	3 pole		CA10.A202/GBA003.*PN	70069948	PN1G	
Off-On <sup>1)</sup>	4 pole		CA10.A203/GBA003.*PN	70069958	PN1G	
Changeover, with Off <sup>1)</sup>	2 pole		CA10.A211/GBA009.*PN	70054352	PN1G	
Changeover, without Off <sup>1)</sup>	2 pole		CA10.A221/GBA003.*PN	70069959	PN1G	
Changeover, spring return to Off <sup>2)</sup>	2 pole		CA10.A215/GBA002.*PN	70069949	PN1G	
Step, 3 pos'n, without Off <sup>1)</sup>	1 pole		CA10.A230/GBA002.*PN	70069960	PN1G	
Step, 4 pos'n, without Off <sup>1)</sup>	1 pole		CA10.A231/GBA004.*PN	70069961	PN1G	





Notes 1) Key removable in all positions.  
2) Key removable in '0' position only.

## Emergency-Off Load switch 25A & 32A

3, & 4 POLE



- IP RATING** IP65 protection
- ENCLOSURE** grey insulated enclosure
- HANDLE OPTION** red/yellow padlockable handle
- EARTH TERMINAL** included
- FEATURE** suitable for safety isolation in accordance with IEC 60947-3/BS EN 60947-3

AC-21A	Order Code No.	Article No.	Encl.Ref.
<b>3 pole</b>			
25A	GB2.KN5 	70054986	PF1E
32A	GB2.KN7 	70055004	PF1E
<b>4 pole (3 ph+Sw N<sup>1)</sup>)</b>			
25A	GB2.KN6 	70054984	PF1E
32A	GB2.KN8 	70055003	PF1E

## Motor Reversing Load switch

3 Phase 5.5kW @ 415V  
1 Phase 1.5kW @ 240V



- IP RATING** IP42 protection
- ENCLOSURE** grey insulated enclosure
- HANDLE OPTION** grey handle/silver legend
- EARTH TERMINAL** included

Order Code No.	Article No.	Encl.Ref.
GB2.KN4 	70054725	PN1C

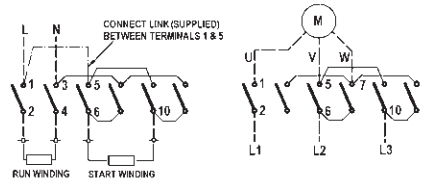

CONNECT LINK (SUPPLIED) BETWEEN TERMINALS 1 & 5

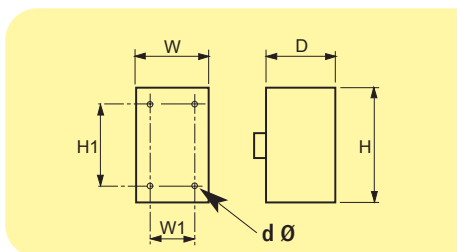

### DIMENSIONS for ALL switches on this page

Encl. Ref.	Encl. Dim.			Encl. Dim.			Cable Entries.
	H	W	D	H1	W1	d	
PF1A	72	64	42	36	50	4.4	4 x 20mm ISO
PF1B	72	64	51	36	50	4.4	4 x 20mm ISO
PF1E	92	82	65	52	68	4.4	4 x 20mm ISO
PN1C	72	64	56	36	50	4.4	4 x 20mm ISO
PN1G	72	64	69	36	50	4.4	4 x 20mm ISO

Switch Type	Thermal Rating	Insulation Voltage, U <sub>i</sub>	Rated operating Current & power				Short Circuit Protection	Terminal Capacity		
			Operational current, I <sub>e</sub>		Operational Power, 3 ph.			Max. fuse gI/gG char.	Single core/stranded wire.	Flexible wire, with sleeve.
	Enclosed rating I <sub>the</sub>		AC-15	AC-21A	AC-3	AC-23A	A			
	A	V	110V 220-240V 380-440V	690V	220-240V 380-440V	230-240V 380-440V	A	mm <sup>2</sup>	mm <sup>2</sup>	mm <sup>2</sup>
<b>Switch-disconnectors - selection data in accordance with: IEC 60947, IEC 60204, BS EN 60947, BS EN 60204</b>										
KG10	20	690	- - -	20	2.2 3.7	3 5.5	20	2.5	1.5	-
KG20	25	690	- - -	25	4 5.5	5.5 7.5	35	6	4	-
KG32	32	690	- - -	32	5.5 7.5	5.5 11	35	6	4	-
KG41	40	690	- - -	40	7.5 11	7.5 15	50	16	10	-
KG64	63	690	- - -	63	11 18.5	11 22	63	16	10	-
KG80	80	690	- - -	80	15 22	18.5 30	80	50	35	-
KG100	100	690	- - -	100	18.5 30	22 37	100	50	35	-
KG105	125	690	- - -	125	22 37	25 45	125	50	35	-
KG125	125	1000 <sup>1)</sup>	- - -	125	22 37	30 45	125	95	70	-
KG160	160	1000 <sup>1)</sup>	- - -	160	30 45	30 55	160	95	70	-
KG210	200	1000 <sup>1)</sup>	- - -	200	37 55	37 75	200	185	120	-
KG250	250	1000 <sup>1)</sup>	- - -	250	37 55	37 90	250	185	120	-
KG315	315	1000 <sup>1)</sup>	- - -	315	45 75	55 110	315	185	120	-
KH16	16	800 <sup>1)</sup>	- - -	16	3 5.5	4.5 7.5	25	6	4	-
KH20	20	800 <sup>1)</sup>	- - -	20	3.5 6.5	5.5 10	32	6	4	-
KH25	25	800 <sup>1)</sup>	- - -	25	4 7.5	7 12	35	6	4	-
KH32	32	800 <sup>1)</sup>	- - -	32	5.5 11	9 16	35	10	6	-
KH40	40	800 <sup>1)</sup>	- - -	40	7.5 15	11 20	50	10	6	-
KH63	63	1000 <sup>1)</sup>	- - -	63	11 22	18.5 30	80	35	25	-
KH80	80	1000 <sup>1)</sup>	- - -	80	15 30	23 40	100	35	25	-
KH85	100	1000 <sup>1)</sup>	- - -	100	3) 3)	3) 3)	100	35	25	-
GB2.250/A	250	1000	- - -	250	- -	75 140	315	150		M8
GB2.315/A	315	1000	- - -	315	- -	100 160	500	240		M10
GB2.400/A	400	1000	- - -	400	- -	132 220	500	240		M10
GB2.630/A	630	1000	- - -	630	- -	200 355	800	400/2x155		M12
GB2.800/A	800	1000	- - -	800	- -	250 450	800	500/2x240		M12
GB2.1000/A	1000	1000	- - -	1000	- -	- 560	1250	630/2x400		M12
GB2.1250/A	1250	1000	- - -	1250	- -	- 710	1250	2x400		M12
C200-4	200	690	- - -	200	22 37	37 75	200	95	95	M8
C316 (6 pole) (in RB10, MB10, SB10 encl)	275	1000	- - -	275	37 55	75 132	315	150	150	M12
C316 (6 pole) (in RB29, MB29, SB29 encl)	315	1000	- - -	315	37 55	75 132	315	185	150	M12
C316 (3 + 4 pole) (in GP27 encl)	315	1000	- - -	315	37 55	75 132	315	150	150	M12
<b>Switch &amp; Control Stations - selection data in accordance with: IEC 60947, BS EN 60947.</b>										
CA4	10	440	- 2.5 1.5	10	0.55 2.2	0.75 3	10	2x1.5	2x1.5	-
CA25	32	690	12 12 6	32	5.5 11	7.5 15	35	2x6	2x4	-
C32	50	690	16 16 7	40	7.5 15	11 22	63	2x10	2x6	-
C42	63	690	- - -	63	11 18.5	15 30	80	2x16	2x10	-
C80	115	690	- - -	100	15 30	30 45	125	35	25	-
C125	150	690	- - -	150	22 37	37 75	200	70	50	-
C200-4	200	690	- - -	200	22 37	37 75	200	95	95	M8
C315 (In MB10 encl)	275	690	- - -	275	37 55	75 132	315	150	150	M12
C315 (In MB29 encl)	315	690	- - -	315	37 55	75 132	315	185	150	M12
GB2.KN1/KN2/KN3/KN10/CA10	20	690	5 5 4	20	3 5.5	3.7 7.5	25	2x2.5	2x2.5	-
GB2.KN4	20	690	- - -	-	3 <sup>2)</sup> 5.5 <sup>2)</sup>	- -	25	2x2.5	2x2.5	-
GB2.KN5/KN6	25	690	8 8 5	25	4 7.5	5.5 11	35	2x4	2x2.5	-
GB2.KN7/KN8	32	690	14 14 6	32	5.5 11	7.5 15	50	2x6	2x4	-
P N/P SN	6	500	6 6 4	-	- -	- -	10	2.5	1.5	-

Notes: 1) Only valid for no-load switching (AC-20A) above 690v.  
2) 1 phase, 240v, rating = 1.5kW.

3) KH85 is only available as 2 pole changeover switch.  
Single phase rating @240v: AC-3 = 10kW, 62A. AC-23A = 11kW, 68A.

# IP Codes



A coding system is defined by BS EN 60529 for the classification of degrees of protection provided by enclosures of electrical equipment against solid objects and water. This coding comprises the letters 'IP' followed by a two digit code as follows:-

**IP 6 5**

**Defines protection against solid objects and access to hazardous parts.**

**Defines protection against water.**

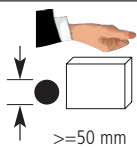
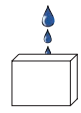
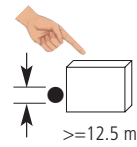
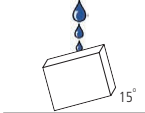
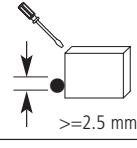
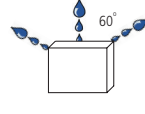
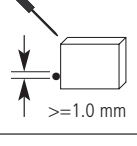
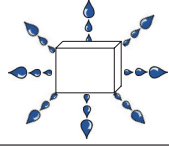
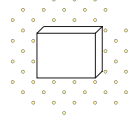
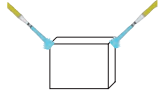
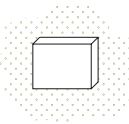
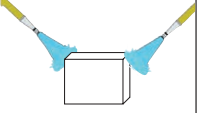
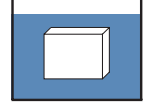
Degrees of protection indicated by a number up to and including '6' implies compliance with the requirements for all lower numbers. For a code with a second digit of 7 or 8, a second code must be stated to specify protection against water jets or spray. eg IP66/IP67.

1st Digit	Protection against solid objects and access to hazardous parts.	2nd Digit	Protection against water
0	No protection	0	No protection
1	 No ingress by solid objects $\geq 50$ mm dia nor access to hazardous parts with the back of the hand	1	 Vertically falling drops of water shall have no harmful effect.
2	 No ingress by solid objects $\geq 12.5$ mm dia nor access to hazardous parts with a finger.	2	 Vertically falling drops of water shall have no harmful effect when the enclosure is tilted at any angle up to $15^\circ$ from vertical.
3	 No ingress by solid objects $\geq 2.5$ mm dia nor access to hazardous parts with a tool.	3	 Water sprayed at up to $60^\circ$ from the vertical shall have no harmful effect.
4	 No ingress by solid objects $\geq 1.0$ mm dia nor access to hazardous parts with a wire.	4	 Water splashed from any direction shall have no harmful effect.
5	 Dust protected. Ingress of dust is not completely prevented, but there should be no harmful deposits. No access to hazardous parts with a wire.	5	 Jets of water projected from any direction shall have no harmful effect.
6	 Dust-tight. No ingress of dust. No access to hazardous parts with a wire.	6	 Strong jets of water projected from any direction shall have no harmful effect.
		7	 Temporary immersion in water shall not result in ingress of harmful quantities of water.
		8	 Continuous immersion in water shall not result in ingress of harmful quantities of water.

Reference should be made to BS EN 60529:1992 for full details concerning test and acceptance criteria.

**Specification for IP69K - The IP69K rating is for applications where high pressure and high temperature washdown is used to sanitize equipment, prescribed by Germany standard DIN 40050 PART9** Products rated to IP69K must be able to withstand high-pressure and steam cleaning. • The test specifies a spray nozzle that is fed with 80 °C water at 80–100 bar (~1160-1450) and a flow rate of 14–16 L/min. • The nozzle is held 10–15 cm from the tested device at angles of 0°, 30°, 60° and 90° for 30 seconds each. • The test device sits on a turntable that rotates once every 12 seconds.

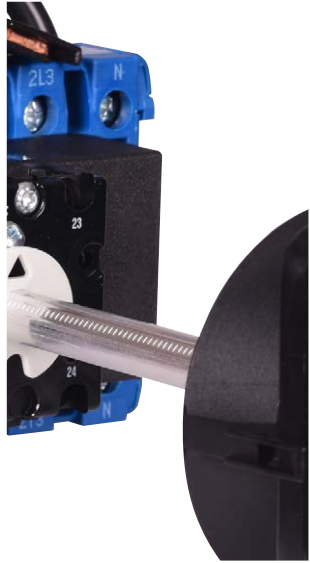

# Switch-disconnectors

## open switches

This section contains the most popular Kraus & Naimer Blue Line switch-disconnectors including our range of main/emergency-off switches, main switches and changeover switches.

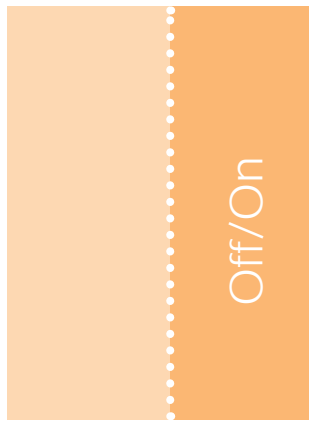

### Off/On Switch-disconnectors

#### Main/Emergency-Off Switch

Front Panel Mounting Single Hole Fixing Handle	32
Front Panel Mounting 4 Hole Fixing Handle	33
Base Mounting Local Padlockable Handle	32
Base Mounting Single Hole Fixing Handle	34-35
Base Mounting 4 Hole Fixing Handle	34-35
<b>Main/Emergency-Off Switch with Defeatable Door Interlock</b>	
Base Mounting Single Hole Fixing Handle	36
Base Mounting 4 Hole Fixing Handle	37

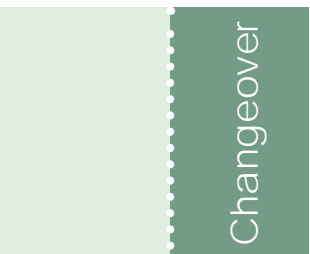

### Changeover Switch-disconnectors

#### Changeover Switch with Centre Off

Base Mounting 4 Hole Fixing Handle 2, 3 & 4 pole 16A to 160A	38
Base Mounting, suitable for 45mm distribution board cutout	38

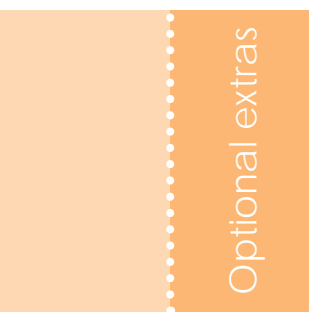

### Optional Extras

Side Mounted Earth Terminal	39
Side Mounted Neutral Terminal	39
Side Mounted Auxiliary Contact	39
Mounting Tool	39
Terminal Covers	39



### Technical Data, dimensions & general information

Technical Data	40
Connection Diagrams	41
Dimensions	42- 47



# Main/Emergency-Off switch 20A to 32A

Front panel mounting single hole fixing handle

2, 3 & 4 POLE



**IP RATING** IP66/67/69K front protection

**HANDLE OPTION** Red & yellow padlockable handle or black & silver option

**FRONT PLATE SIZE** 48mm x 48mm

**FEATURES** fingerproof terminals

variations on auxiliaries available plus add-on auxiliary blocks for KG20 & KG32 (see page 39)

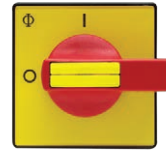

WITHOUT AUXILIARIES

le AC-21A	2 Pole	Article No.	
20A	KG10A.T202/04.FT2	70006518	
25A			
32A			
le AC-21A	3 Pole	Article No.	
20A	KG10A.T203/04.FT2	70011108	
25A	KG20A.T203/04.FT2	70010756	
32A	KG32A.T203/04.FT2	70010764	
le AC-21A	3 Pole + Solid Neutral	Article No.	
20A			
25A	KG20A.T207/04.FT2	70075345	
32A	KG32A.T207/04.FT2	70075346	
le AC-21A	4 Pole (3ph + Sw N <sup>2</sup> )	Article No.	
20A	KG10A.T204/04.FT2	70011426	
25A	KG20A.T204/04.FT2	70025953	
32A	KG32A.T204/04.FT2	70021516	

The following auxiliary contacts are provided:-

**KG10A** 1 n.o. (early break) + 1 n.c. **KG20A, KG32A** 2 n.o. (early break)  
2) Switched neutral pole is early make/late break

3 Pole + Aux	Article No.	le AC-21A
KG10A.T203/GBA319.FT2	70054222	20A
KG20A.T203/GBA320.FT2	70075348	25A
KG32A.T203/GBA320.FT2	70075347	32A
3 Pole + Solid Neutral + Aux	Article No.	le AC-21A
		20A
KG20A.T207/GBA325.FT2	70075349	25A
KG32A.T207/GBA325.FT2	70075351	32A
4 Pole (3ph + Sw N <sup>2</sup> ) + Aux	Article No.	le AC-21A
KG10A.T204/GBA330.FT2	70075353	20A
KG20A.T204/GBA330.FT2	70075358	25A
KG32A.T204/GBA330.FT2	70075359	32A

WITH AUXILIARIES 1

Technical data - Page 40

Connection diagram - Page 41

Dimensions - KG - Page 42

## BASE MOUNTING

# Main/Emergency-Off switch 20A to 160A

Base mounting local padlockable handle

3 & 4 POLE

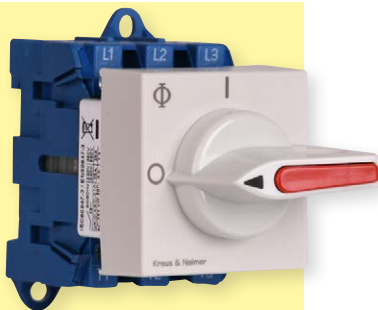

**HANDLE OPTION** grey, padlockable in OFF position

**FRONT PLATE** grey with "0 - 1" legend

**FEATURES** escutcheon suitable for 45mm cut out

fingerproof terminals - KH16 to KH40  
- KG10A - KG64B

suitable for DIN rail mounting

le AC-21A	3 Pole	Article No.	4 Pole (3ph + Sw N <sup>1</sup> )	Article No.
20A	KG10A.T303/58.VE21	70008773	KG10A.T304/58.VE21	70019846
25A	KG20A.T303/58.VE2	70011280	KG20A.T304/58.VE2	70009967
32A	KG32A.T303/58.VE2	70011389	KG32A.T304/58.VE2	70010990
40A	KG41.T303/58.VE2	70010102	KG41.T304/58.VE2	70010824
63A	KG64.T303/58.VE2	70012797	KG64.T304/58.VE2	70010103
80A	KG80.T303/58.VE2	70010250	KG80.T304/58.VE2	70010130
100A	KG100.T303/58.VE2	70012785	KG100.T304/58.VE2	70014367
125A	KG125.T303/58.VE2	70022206	KG125.T304/58.VE2	70074391
160A	KG160.T303/58.VE2	70020523	KG160.T304/58.VE2	70060291

**Notes**

1) Switched neutral pole is early make/late break.

2) Auxiliaries can be fitted on request.



20A to 315A

# Main/Emergency-Off switch

Front panel mounting four hole fixing handle

**IP RATING** IP66/67 front protection

**HANDLE OPTION** Red & yellow padlockable handle, black & silver option available

KG10A to KG160



KG210 to KG315



**FRONT PLATE SIZE** KG10A to KG32A: 48mm x 48mm  
 KG41B to KG105: 64mm x 64mm  
 KG125 to KG315: 88mm x 88mm

**FEATURES** fingerproof terminals (KG10A to KG64B)  
 incoming terminal cover - KG80 to KG315  
 (KG210 to KG315 incl. outgoing cover)

variations on auxiliaries available plus add-on auxiliary blocks (see page 39)

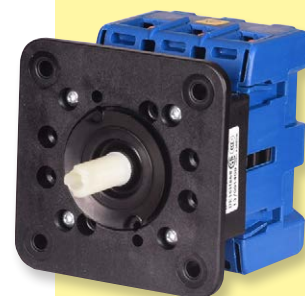
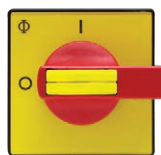

3 & 4 POLE

le AC-21A	3 Pole	Article No.	4 Pole (3ph + Sw N <sup>3</sup> )	Article No.
20A	KG10A.T203/01.E	70023201	KG10A.T204/01.E	70011454
25A	KG20A.T203/01.E	70014345	KG20A.T204/01.E	70024808
32A	KG32A.T203/01.E	70019435	KG32A.T204/01.E	70026015
40A	KG41B.T203/GBA306.E	70023097	KG41B.T204/01.E	70011488
63A	KG64B.T203/GBA306.E	70055470	KG64B.T204/01.E	70011404
80A	KG80.T203/GBA306.E	70055347	KG80.T204/01.E	70009989
100A	KG100.T203/GBA306.E	70055376	KG100.T204/01.E	70011179
125A	KG105.T203/GBA306.E	70055392	KG105.T204/01.E	70011283
125A	KG125 <sup>2</sup> .T203/01.E	70011050	KG125 <sup>2</sup> .T204/01.E	70010303
160A	KG160.T203/01.E	70010013	KG160.T204/01.E	70019089
200A	KG210.T203/05.E	70029411	KG210.T204/05.E	70024438
250A	KG250.T203/05.E	70010014	KG250.T204/05.E	70012800
315A	KG315.T203/05.E	70012749	KG315.T204/05.E	70019216

WITHOUT AUXILIARIES

le AC-21A	3 Pole + Aux	Article No.	4 Pole (3ph + Sw N <sup>3</sup> ) + Aux	Article No.
20A	KG10A.T203/GBA315.E	70075355	KG10A.T204/GBA415.E	70072587
25A	KG20A.T203/GBA315.E	70071736	KG20A.T204/GBA415.E	70075364
32A	KG32A.T203/GBA315.E	70071766	KG32A.T204/GBA415.E	70075365
40A	KG41B.T203/GBA353.E	70032222	KG41B.T204/GBA426.E	70075368
63A	KG64B.T203/GBA353.E	70054569	KG64B.T204/GBA426.E	70075371
80A	KG80.T203/GBA353.E	70075360	KG80.T204/GBA426.E	70075372
100A	KG100.T203/GBA353.E	70040367	KG100.T204/GBA426.E	70075366
125A	KG105.T203/GBA353.E	70075361	KG105.T204/GBA426.E	70075373
125A	KG125 <sup>2</sup> .T203/GBA368.E	70055375	KG125 <sup>2</sup> .T204/GBA045.E	70054681
160A	KG160.T203/GBA025.E	70075362	KG160.T204/GBA045.E	70054653
200A	KG210.T203/GBA025.E	70054684	KG210.T204/GBA035.E	70055280
250A	KG250.T203/GBA025.E	70055384	KG250.T204/GBA035.E	70055281
315A	KG315.T203/GBA025.E	70055279	KG315.T204/GBA035.E	70055461

WITH AUXILIARIES<sup>1</sup>

**Notes** 1) The following auxiliary contacts are provided:- **KG10A** 1 n.o. (early break) + 1 n.c. **KG20A to KG105** 2 n.o. (early break) **KG125-KG315** 2 n.o. (early break) + 2 n.c. 2) Suitable for applications requiring larger cable termination 3) Switched neutral pole is early make/late break



# Main/emergency-off switch

Base mounting single hole fixing handle

20A to 125A



3, 4 & 6 POLE

**IP RATING** IP66 front protection

**HANDLE OPTION** red & yellow padlockable handle or black & silver option available (black & grey depending on type)

**FRONT PLATE SIZE** KG10A to KG32A: 48mm x 48mm  
KG41B to KG105: 64mm x 64mm

**FEATURES**

door interlock  
adjustable metal operating shaft 200mm long, switches with alternative shaft lengths available

fingerproof terminals KG10A - KG64B incoming terminal cover KG80 - KG105 variations on auxiliaries

available plus add-on auxiliary blocks (see page 39)

suitable for DIN rail mounting

Technical data - Page 40

Connection diagram - Page 41

Dimensions - KG - Page 43-44

le AC-21A	3 Pole	Article No.		
20A	KG10A.T203/GBA352.VE	70054547		
25A	KG20A.T203/GBA352.VE	70054190		
32A	KG32A.T203/GBA352.VE	70054246		
40A	KG41B.T203/GBA452.VE	70045507		
63A	KG64B.T203/GBA452.VE	70054179		
80A	KG80.T203/GBA452.VE	70063294		
100A	KG100.T203/GBA452.VE	70063332		
125A	KG105.T203/GBA452.VE	70063333		

le AC-21A	3 Pole + Aux	Article No.		
20A	KG10A.T203/GBA372.VE	70073994		
25A	KG20A.T203/GBA372.VE	70071941		
32A	KG32A.T203/GBA372.VE	70071942		
40A	KG41.T203/GBA462.VE	70063355		
63A	KG64B.T203/GBA462.VE	70063381		
80A	KG80.T203/GBA462.VE	70063382		
100A	KG100.T203/GBA462.VE	70063380		
125A	KG105.T203/GBA462.VE	70063383		

# Main/emergency-off switch

Base mounting four hole fixing handle

20A to 315A



3, 4 & 6 POLE

**IP RATING** IP66/67 front protection

**HANDLE OPTION** red & yellow padlockable handle, black & silver option available (black & grey depending on type)

KG10A to KG160



KG210 to KG315



**FRONT PLATE SIZE** KG10A to KG32A: 48mm x 48mm  
KG20B to KG105: 64mm x 64mm  
KG125 to KG315: 88mm x 88mm

**FEATURES** door interlock

adjustable metal operating shaft 200mm long (KG125 to KG315 300mm long), switches with alternative shaft lengths available on request

fingerproof terminals (KG10A to KG64B) incoming terminal cover - KG80 to KG315 (KG210 to KG315 incl.outgoing cover) variations on auxiliaries available plus add-on auxiliary blocks (see page 39)

suitable for DIN rail mounting - up to KG105

Technical data - Page 40

Connection diagram - Page 41

Dimensions - KG - Page 43-44

le AC-21A	3 Pole	Article No.		
20A	KG10A.T203/GBA430.VE	70054188		
25A	KG20A.T203/GBA430.VE	70054589		
32A	KG32A.T203/GBA430.VE	70053998		
40A	KG41B.T203/GBA430.VE	70054010		
63A	KG64B.T203/GBA430.VE	70055303		
80A	KG80.T203/GBA430.VE	70054022		
100A	KG100.T203/GBA430.VE	70054533		
125A	KG105.T203/GBA430.VE	70055233		
125A	KG125.T203/GBA050.VE	70062245		
160A	KG160.T203/GBA050.VE	70062248		
200A	KG210.T203/GBA015.VE	70062246		
250A	KG250.T203/GBA015.VE	70077069		
315A	KG315.T203/GBA015.VE	70062250		

le AC-21A	3 Pole + Aux	Article No.		
20A	KG10A.T203/GBA435.VE	70054556		
25A	KG20A.T203/GBA435.VE	70053860		
32A	KG32A.T203/GBA435.VE	70055197		
40A	KG41B.T203/GBA435.VE	70054002		
63A	KG64B.T203/GBA435.VE	70050582		
80A	KG80.T203/GBA435.VE	70055098		
100A	KG100.T203/GBA435.VE	70055440		
125A	KG105.T203/GBA435.VE	70054536		
125A	KG125.T203/GBA055.VE	70055033		
160A	KG160.T203/GBA055.VE	70054651		
200A	KG210.T203/GBA030.VE	70055455		
250A	KG250.T203/GBA030.VE	70055242		
315A	KG315.T203/GBA030.VE	70055398		

# BASE MOUNTING

3 Pole + Solid Neutral	Article No.	4 Pole (3ph + Sw N <sup>2</sup> )	Article No.	6 Pole	Article No.
		KG10A.T204/GBA237.VE	70075374		
KG20A.T207/GBA220.VE	70075367	KG20A.T204/GBA237.VE	70075377	KG20B.T206/GBA230.VE	70063519
KG32A.T207/GBA220.VE	70075369	KG32A.T204/GBA237.VE	70075378	KG32B.T206/GBA230.VE	70063520
KG41B.T207/GBA240.VE	70063858	KG41B.T204/GBA447.VE	70063413	KG41B.T206/GBA410.VE	70063521
KG64B.T207/GBA240.VE	70063859	KG64B.T204/GBA447.VE	70063415	KG64B.T206/GBA410.VE	70063522
KG80.T207/GBA240.VE	70063860	KG80.T204/GBA447.VE	70063417	KG80.T206/GBA410.VE	70063523
KG100.T207/GBA240.VE	70063861	KG100.T204/GBA447.VE	70063421	KG100.T206/GBA410.VE	70063524
KG105.T207/GBA240.VE	70063862	KG105.T204/GBA447.VE	70063423	KG105.T206/GBA410.VE	70063525

WITHOUT AUXILIARIES

3 Pole + Solid Neutral + Aux	Article No.	4 Pole (3ph + Sw N <sup>2</sup> ) + Aux	Article No.	6 Pole + Aux	Article No.
		KG10A.T204/GBA247.VE	70075381		
KG20A.T207/GBA225.VE	70075379	KG20A.T204/GBA247.VE	70075382	KG20B.T206/GBA236.VE	70076959
KG32A.T207/GBA225.VE	70075380	KG32A.T204/GBA247.VE	70069683	KG32B.T206/GBA228.VE	70063548
KG41B.T207/GBA245.VE	70063872	KG41B.T204/GBA457.VE	70063506	KG41B.T206/GBA415.VE	70076969
KG64B.T207/GBA245.VE	70063873	KG64B.T204/GBA457.VE	70063507	KG64B.T206/GBA415.VE	70077046
KG80.T207/GBA245.VE	70063874	KG80.T204/GBA457.VE	70063509	KG80.T206/GBA415.VE	70063553
KG100.T207/GBA245.VE	70063875	KG100.T204/GBA457.VE	70063511	KG100.T206/GBA415.VE	70063554
KG105.T207/GBA245.VE	70077059	KG105.T204/GBA457.VE	70063502	KG105.T206/GBA415.VE	70063615

WITH AUXILIARIES<sup>1</sup>

**Notes** 1) The following auxiliary contacts are provided:- **KG10A** 1 n.o. (early break) +1 n.c. **KG20A to KG105** 2 n.o. (early break)  
 2) Suitable for applications requiring larger cable termination 3) Switched neutral pole is early make/late break

3 Pole + Solid Neutral	Article No.	4 Pole (3ph + Sw N <sup>3</sup> )	Article No.	6 Pole	Article No.
		KG10A.T204/GBA450.VE	70054047		
KG20A.T207/GBA140.VE	70055369	KG20A.T204/GBA450.VE	70069322	KG20B.T206/GBA221.VE	70062495
KG32A.T207/GBA140.VE	70071547	KG32A.T204/GBA450.VE	70072339	KG32B.T206/GBA221.VE	70062502
KG41B.T207/GBA140.VE	70055469	KG41B.T204/GBA450.VE	70054004	KG41B.T206/GBA221.VE	70062507
KG64B.T207/GBA140.VE	70055492	KG64B.T204/GBA450.VE	70053711	KG64B.T206/GBA221.VE	70062510
KG80.T207/GBA140.VE	70055439	KG80.T204/GBA450.VE	70055437	KG80.T206/GBA221.VE	70062513
KG100.T207/GBA140.VE	70055230	KG100.T204/GBA450.VE	70055441	KG100.T206/GBA221.VE	70062515
KG105.T207/GBA140.VE	70055198	KG105.T204/GBA450.VE	70036139	KG105.T206/GBA221.VE	70062517
KG125 <sup>2</sup> .T207/GBA151.VE	70063743	KG125 <sup>2</sup> .T204/GBA100.VE	70062420	KG125 <sup>2</sup> .T206/GBA061.VE	70062519
KG160.T207/GBA151.VE	70063744	KG160.T204/GBA100.VE	70062427	KG160.T206/GBA061.VE	70062521
KG210.T207/GBA156.VE	70063745	KG210.T204/GBA020.VE	70055448		
KG250.T207/GBA156.VE	70063746	KG250.T204/GBA020.VE	70029036		
KG315.T207/GBA157.VE	70063748	KG315.T204/GBA020.VE	70062436		

WITHOUT AUXILIARIES

3 Pole + Solid Neutral + Aux	Article No.	4 Pole (3ph + Sw N <sup>3</sup> ) + Aux	Article No.	6 Pole + Aux	Article No.
		KG10A.T204/GBA455.VE	70054102		
KG20A.T207/GBA145.VE	70055368	KG20A.T204/GBA455.VE	70055399	KG20B.T206/GBA225.VE	70054103
KG32A.T207/GBA145.VE	70055370	KG32A.T204/GBA455.VE	70055462	KG32B.T206/GBA225.VE	70055465
KG41B.T207/GBA145.VE	70055471	KG41B.T204/GBA455.VE	70055466	KG41B.T206/GBA225.VE	70055228
KG64B.T207/GBA145.VE	70055493	KG64B.T204/GBA455.VE	70055491	KG64B.T206/GBA225.VE	70054668
KG80.T207/GBA145.VE	70054985	KG80.T204/GBA455.VE	70055438	KG80.T206/GBA225.VE	70055382
KG100.T207/GBA145.VE	70055236	KG100.T204/GBA455.VE	70055442	KG100.T206/GBA225.VE	70054187
KG105.T207/GBA145.VE	70055365	KG105.T204/GBA455.VE	70055226	KG105.T206/GBA225.VE	70055252
KG125 <sup>2</sup> .T207/GBA150.VE	70063760	KG125 <sup>2</sup> .T204/GBA105.VE	70054168	KG125 <sup>2</sup> .T206/GBA070.VE	70054620
KG160.T207/GBA150.VE	70063761	KG160.T204/GBA105.VE	70055043	KG160.T206/GBA070.VE	70055400
KG210.T207/GBA155.VE	70063762	KG210.T204/GBA040.VE	70055456		
KG250.T207/GBA155.VE	70063763	KG250.T204/GBA040.VE	70055238		
KG315.T207/GBA155.VE	70077056	KG315.T204/GBA040.VE	70055362		

WITH AUXILIARIES<sup>1</sup>

**Notes** 1) The following auxiliary contacts are provided:- **KG10A** 1 n.o. (early break) +1 n.c. **KG20A to KG105** 2 n.o. (early break)  
**KG125 to KG315** 2 n.o. (early break) +2 n.c. 2) Suitable for applications requiring larger cable termination 3) Switched neutral pole is early make/late break



# Main/emergency-Off switch

25A to 160A

Base mounting single hole fixing handle

3 & 4 POLE

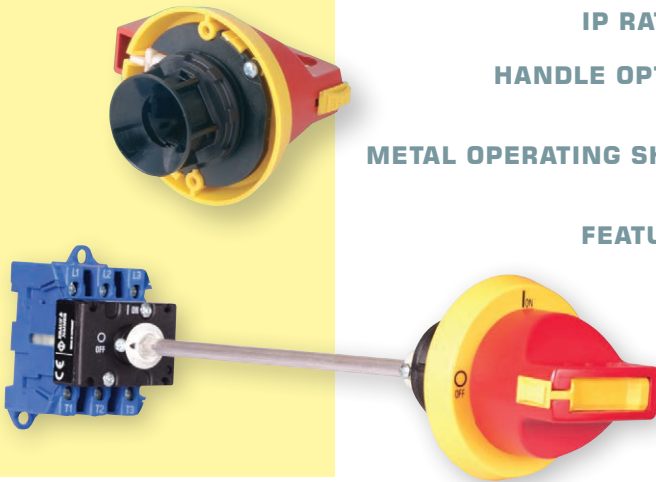

**IP RATING** IP66/67 front protection

**HANDLE OPTION** red & yellow padlockable handle or black & silver option available

**METAL OPERATING SHAFT** KG20B to KG105: 200mm long  
KG125 to KG160: 300mm long

**FEATURES** alternative shaft lengths available on request

fingerproof terminals -KG20B to KG64B

incoming terminal cover -KG80 to KG160

suitable for DIN rail mounting up to KG105

variations on auxiliaries available plus add-on auxiliary blocks (see page 39)

WITHOUT AUXILIARIES

ie AC-21A	3 Pole	Article No.	4 Pole (3ph + Sw N <sup>2</sup> )	Article No.
25A	KG20B.T203/GBA340.VE	70075384	KG20B.T204/GBA350.VE	70070722
32A	KG32B.T203/GBA340.VE	70075387	KG32B.T204/GBA350.VE	70075435
40A	KG41B.T203/GBA370.VE	70075389	KG41B.T204/GBA380.VE	70075436
63A	KG64B.T203/GBA370.VE	70072697	KG64B.T204/GBA380.VE	70072864
80A	KG80.T203/GBA370.VE	70075414	KG80.T204/GBA380.VE	70075440
100A	KG100.T203/GBA370.VE	70075416	KG100.T204/GBA380.VE	70075441
125A	KG105.T203/GBA370.VE	70075417	KG105.T204/GBA380.VE	70060752
125A <sup>3</sup>	KG125.T203/GBA180.VE	70075430	KG125.T204/GBA190.VE	70075437
160A	KG160.T203/GBA180.VE	70075433	KG160.T204/GBA190.VE	70075439

WITH AUXILIARIES<sup>1</sup>

ie AC-21A	3 Pole + Aux	Article No.	4 Pole (3ph + Sw N <sup>2</sup> ) + Aux	Article No.
25A	KG20B.T203/GBA345.VE	70071821	KG20B.T204/GBA355.VE	70076833
32A	KG32B.T203/GBA345.VE	70070923	KG32B.T204/GBA355.VE	70076836
40A	KG41B.T203/GBA375.VE	70076830	KG41B.T204/GBA385.VE	70076837
63A	KG64B.T203/GBA375.VE	70076831	KG64B.T204/GBA385.VE	70076838
80A	KG80.T203/GBA375.VE	70076772	KG80.T204/GBA385.VE	70076777
100A	KG100.T203/GBA375.VE	70076773	KG100.T204/GBA385.VE	70076778
125A	KG105.T203/GBA375.VE	70076832	KG105.T204/GBA385.VE	70076839
125A <sup>3</sup>	KG125.T203/GBA185.VE	70076774	KG125.T204/GBA195.VE	70076779
160A	KG160.T203/GBA185.VE	70076776	KG160.T204/GBA195.VE	70076780

**Notes**

1) The following auxiliary contacts are provided:-  
 KG10A 1 n.o. (early break) + 1 n.c.  
 KG20A to KG105 2 n.o. (early break)  
 KG125 to KG160 2 n.o. (early break) + 2 n.c.

2) Switched neutral pole is early make/late break

3) Suitable for applications requiring larger cable terminations than KG105

Technical data - Page 40

Connection diagram - Page 41

Dimensions - KG - Page 43

When required for maintenance purposes, qualified personnel can defeat the door interlock and enable the panel door to be opened whilst the switch is in the 'ON' position. Door clutch will accept 3mm

misalignment between switch shaft and door mounted handle. In normal operation the switch handle is padlockable in the OFF position only and interlocked with the shaft in the ON position to

prevent opening of the panel door. Shaft and handle are also interlocked in the OFF position if a padlock is fitted to the handle with the panel door closed.

defeatable door interlock

# BASE MOUNTING - DEFEATABLE DOOR INTERLOCK

40A to 315A

## Main/emergency-Off switch

Base mounting four hole fixing handle

**IP RATING** IP66 front protection

**HANDLE OPTION** red & yellow padlockable handle or black & silver option available

**METAL OPERATING SHAFT** KG41B to KG105: 200mm long  
KG125 to KG315: 300mm long

**FEATURES** alternative shaft lengths available on request

fingerproof terminals -KG41B to KG64B

incoming terminal cover -KG80 to KG315  
(KG210 to KG315 also incl. outgoing cover)

suitable for DIN rail mounting up to KG105

variations on auxiliaries available plus add-on auxiliary blocks (see page 39)

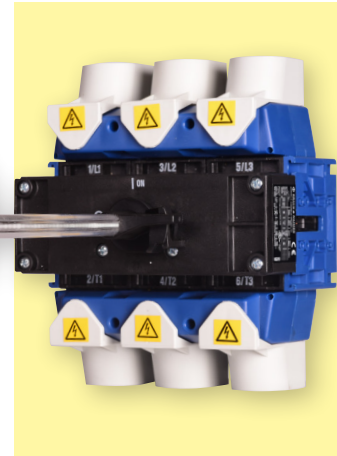

3, 4 & 6 POLE

le AC-21A	3 Pole	Article No.	4 Pole (3ph + Sw N <sup>2</sup> )	Article No.	6 Pole	Article No.
40A	KG41B.T203/GBA330.VE	70069397	KG41B.T204/GBA060.VE	70011135	KG41B.T206/GBA121.VE	70075463
63A	KG64B.T203/GBA330.VE	70011792	KG64B.T204/GBA060.VE	70020234	KG64B.T206/GBA121.VE	70077349
80A	KG80.T203/GBA330.VE	70072322	KG80.T204/GBA060.VE	70075445	KG80.T206/GBA121.VE	70076767
100A	KG100.T203/GBA330.VE	70075442	KG100.T204/GBA060.VE	70075452	KG100.T206/GBA121.VE	70076768
125A	KG105.T203/GBA330.VE	70072436	KG105.T204/GBA060.VE	70010365	KG105.T206/GBA121.VE	70076769
125A <sup>3</sup>	KG125.T203/GBA080.VE	70075444	KG125.T204/GBA090.VE	70073314	KG125.T206/GBA104.VE	70072950
160A	KG160.T203/GBA080.VE	70073327	KG160.T204/GBA090.VE	70069984	KG160.T206/GBA104.VE	70076771
200A	KG210.T203/GBA080.VE	70073329	KG210.T204/GBA090.VE	70022048		
250A	KG250.T203/GBA080.VE	70035192	KG250.T204/GBA090.VE	70025477		
315A	KG315.T203/GBA080.VE	70073330	KG315.T204/GBA090.VE	70075455		

WITHOUT AUXILIARIES

le AC-21A	3 Pole + Aux	Article No.	4 Pole (3ph + Sw N <sup>1</sup> ) + Aux	Article No.	6 Pole + Aux	Article No.
40A	KG41B.T203/GBA335.VE	70076840	KG41B.T204/GBA065.VE	70076783	KG41B.T206/GBA125.VE	70076854
63A	KG64B.T203/GBA335.VE	70076782	KG64B.T204/GBA065.VE	70076848	KG64B.T206/GBA125.VE	70076855
80A	KG80.T203/GBA335.VE	70076841	KG80.T204/GBA065.VE	70076849	KG80.T206/GBA125.VE	70076856
100A	KG100.T203/GBA335.VE	70076842	KG100.T204/GBA065.VE	70075935	KG100.T206/GBA125.VE	70076857
125A	KG105.T203/GBA335.VE	70076843	KG105.T204/GBA065.VE	70076850	KG105.T206/GBA125.VE	70076858
125A <sup>3</sup>	KG125.T203/GBA085.VE	70073242	KG125.T204/GBA095.VE	70058680	KG125.T206/GBA105.VE	70076859
160A	KG160.T203/GBA085.VE	70076844	KG160.T204/GBA095.VE	70076785	KG160.T206/GBA105.VE	70076860
200A	KG210.T203/GBA085.VE	70076845	KG210.T204/GBA095.VE	70076851		
250A	KG250.T203/GBA085.VE	70076846	KG250.T204/GBA095.VE	70076852		
315A	KG315.T203/GBA085.VE	70076847	KG315.T204/GBA095.VE	70076853		

WITH AUXILIARIES<sup>1</sup>

**Notes**

1) The following auxiliary contacts are provided:-  
KG10A 1 n.o. (early break) + 1 n.c.  
KG20A to KG105 2 n.o. (early break)  
KG125 to KG 315 2 n.o. (early break) + 2 n.c.

2) Switched neutral pole is early make/late break

3) Suitable for applications requiring larger cable terminations than KG105

Technical data - Page 40

Connection diagram - Page 41

Dimensions - KG - Page 43

When required for maintenance purposes, qualified personnel can defeat the door interlock and enable the panel door to be opened whilst the switch is in the 'ON' position. Door clutch will accept 3mm

misalignment between switch shaft and door mounted handle. In normal operation the switch handle is padlockable in the OFF position only and interlocked with the shaft in the ON position to

prevent opening of the panel door. Shaft and handle are also interlocked in the OFF position if a padlock is fitted to the handle with the panel door closed.

defeatable door interlock



# Changeover switch, centre off

Base mounting four hole fixing handle

2, 3 & 4 POLE

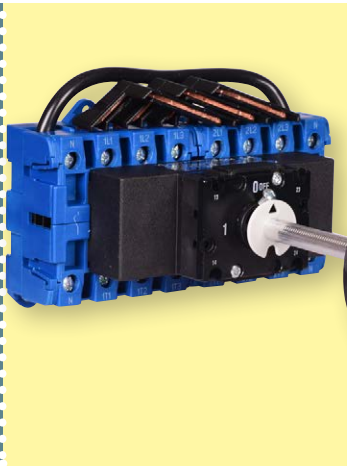

- IP RATING** IP66/67 front protection
- HANDLE OPTION** black/silver padlockable handle
- FRONT PLATE SIZE** KH16 to KH85: 64mm x 64mm  
KG20B to KG64B: 64mm x 64mm  
KG80 to KG160 88mm x 88mm
- METAL OPERATING SHAFT FEATURES**
  - 120mm long KH16 to KH25, KG20B & KG32B
  - 130mm long KH32 to KH85, KG41B to KG105
  - 190mm long KG125 & KG160
- door interlock
- alternative shaft lengths available
- fingerproof terminals -KH16 to KH40  
-KG20B to KG64B
- incoming terminal cover -KG80 to KG105

suitable for DIN rail mounting up to KG105 and all KH switches

le AC-21A	2 Pole	Article No.	3 Pole + aux <sup>1)</sup>	Article No.	4 Pole (3ph + Sw N <sup>2)</sup> + aux <sup>1)</sup>	Article No.
16A	KH16.T902/GBA005.VE	70055495				
20A	KH20.T902/GBA005.VE	70055487				
25A	KH25.T902/GBA005.VE	70055500	KG20B.T903/GBA005.VE	70054057	KG20B.T904/GBA006.VE	70055454
32A	KH32.T902/GBA005.VE	70054539	KG32B.T903/GBA005.VE	70054592	KG32B.T904/GBA006.VE	70054565
40A	KH40.T902/GBA005.VE	70055394	KG41B.T903/GBA005.VE	70063576	KG41B.T904/GBA006.VE	70054213
63A	KH63.T902/GBA005.VE	70055297	KG64B.T903/GBA005.VE	70054180	KG64B.T904/GBA006.VE	70054217
80A	KH80.T902/GBA005.VE	70055507	KG80.T903/GBA005.VE	70054676	KG80.T904/GBA006.VE	70054576
100A	KH85.T902/GBA005.VE	70055239	KG100.T903/GBA005.VE	70054646	KG100.T904/GBA006.VE	70052605
125A			KG105.T903/GBA005.VE	70054712	KG105.T904/GBA006.VE	70054545
125A <sup>3)</sup>			KG125 <sup>3)</sup> .T903/GBA010.VE	70054682	KG125 <sup>3)</sup> .T904/GBA020.VE	70055374
160A			KG160.T903/GBA010.VE	70054537	KG160.T904/GBA020.VE	70055045

- Notes**
- 1) 2-off volt-free, early break, auxiliary contacts are provided. One of these contacts closes in pos. 1 and the other contact closes in pos. 2. Both of the contacts are open in the Off position.
  - 2) Switched neutral pole is early make/late break
  - 3) Suitable for applications requiring larger cable terminations than KG105
- Technical data - Page 40  
 Connection diagram - Page 41  
 Dimensions - **KG** - Page 45  
 - **KH** - page 47

# Changeover switch, centre off

Base mounting

2 & 4 POLE

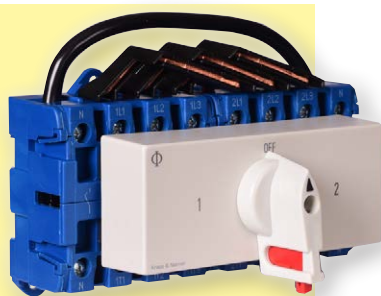

- HANDLE OPTION** grey, padlockable in OFF position
- FRONT PLATE** grey with "1 - OFF - 2" legend
- FEATURES** escutcheon suitable for 45mm cut out
- fingerproof terminals - KH16 to KH40  
- KG41B & KG64B
- suitable for DIN rail mounting

le AC-21A	2 Pole	Article No.	4 Pole (3ph + Sw N <sup>1)</sup>	Article No.
16A	KH16.T902/GBA011.VE2	70055286		
20A	KH20.T902/GBA011.VE2	70076861		
25A	KH25.T902/GBA011.VE2	70076885		
32A	KH32.T902/GBA011.VE2	70055237		
40A	KH40.T902/GBA011.VE2	70076886	KG41B.T904/GBA035.VE2	70076789
63A	KH63.T902/GBA011.VE2	70055504	KG64B.T904/GBA035.VE2	70055287
80A	KH80.T902/GBA011.VE2	70053696	KG80.T904/GBA035.VE2	70076862
100A	KH85.T902/GBA011.VE2	70055508	KG100.T904/GBA035.VE2	70055204
125A			KG105.T904/GBA035.VE2	70076863

- Notes**
- 1) Switched neutral pole is early make/late break.
- Technical data - Page 40  
 Connection diagram - Page 41  
 Dimensions - **KG** - Page 46  
 - **KH** - page 47

## Earth terminal

Switch Type	Order Code No.	Article No.	
KG20A, KG32A, KG20B, KG32B	K0.H052/A	2000019	
KG41B, KG64B	K1.H052/B	2145758	
KG80 - KG105	K2.H052/C	2146137	



SIDE MOUNTED

## Neutral terminal (fully rated)

Switch Type	Order Code No.	Article No.	
KG20A, KG32A, KG20B, KG32B	K0.H053/A	2000020	
KG41B, KG64B	K1.H053/B	2145760	
KG80 - KG105	K2.H053/C	2146139	



SIDE MOUNTED

## Auxiliary contacts

Switch Type	Contact Arrangements	Contact Rating		Order Code No.	Article No.
		AC-21A	AC-15 @ 110-240V		
<b>Panel Mounting E &amp; FT</b>					
KG20A, KG32A	1 n.o. + 1 n.c.	10A	2.5A	K0.H010/A11-E	2148130
KG41B, KG64B	1 n.o. + 1 n.c.	16A	6A	K1.H010/A11-E	2148548
KG80 - KG105	1 n.o. + 1 n.c.	16A	6A	K2.H010/A11-E	2138586
KG125, KG160	2 n.o. + 1 n.c.	16A	6A	K3A.H010/A21-E	2150117
KG210 - KG315	2 n.o. + 1 n.c.	16A	6A	K3.H010/A21-E	2149795
<b>Base Mounting VE</b>					
KG20A, KG20B, KG32A, KG32B	1 n.o. + 1 n.c.	10A	2.5A	K0.H010/A11-VE	2000018
KG41B, KG64B	1 n.o. + 1 n.c.	16A	6A	K1.H010/A11-VE	2148551
KG80 - KG105	1 n.o. + 1 n.c.	16A	6A	K2.H010/A11-VE	2149126
KG125 - KG160	2 n.o. + 1 n.c.	16A	6A	K3A.H010/A21-VE	2150121
KG210 - KG315	2 n.o. + 1 n.c.	16A	6A	K3.H010/A21-VE	2149799



SIDE MOUNTED

KG switches are also available with a variety of factory fitted auxiliary contacts. Please enquire for details.

## Mounting tool

Switch Type	Order Code No.	Article No.	Price (€)
For single hole mounting operators	S00.T170.09	2005361	1.75



SINGLE HOLE

## Terminal covers

Switch Type	Order Code No. 3 main terminals	Article No.	Order Code No. 4 main terminals	Article No.
KG10A	S0.M160/A12.K2	2026554	S0.M160/A12.K2	2026554
KG20A&B/KG32A&B	K0.M160/3	2145329	K0.M160/4	2145330
KG41B/KG64B	K1.M160/3	2139001	K1.M160/4	2145762
KG80/KG105	K2.M160/3	2146141	K2.M160/4	2146142
KG125/KG160	K3.M160/32	2149933	K3.M160/42	2149938
KG210/KG315	K3.M160/30	2149931	K3.M160/40	2149936
KH32/KH40			K1.M160/45.VE <sup>1)</sup>	2148581
KH63/KH85			K1.M160/44.VE <sup>1)</sup>	2148579

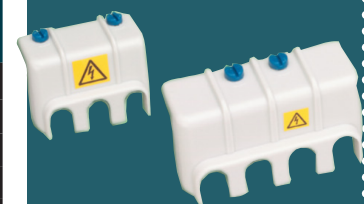

3 & 4 MAIN TERMINALS

**Notes**

1) Suffix VE is applicable for base mounting switches only

# Switch disconnectors

Switch Type	Thermal Rating	Insulation Voltage, Ui	Rated Operating Current & Power								Short Circuit Protection	Terminal Capacity			
			Operational Current, Ie				Operational Power					Max. fuse gL/gG char.	Single core/stranded wire	Flexible wire/with sleeve	Terminal bolt for Cu bar/lug
			AC-15	AC-21A	AC-3		AC-23A		A	mm <sup>2</sup>					
	lth		110v	690v	220-240v, 1 ph.	220-240v, 3 ph.	380-440v, 3 ph.	220-240v, 1 ph.	220-240v, 3 ph.	380-440v, 3 ph.					
	Open rating		220-240v	380-440v											
	A	V	A				kW				A	mm <sup>2</sup>	mm <sup>2</sup>	mm	
Switch-disconnectors - selection data in accordance with: IEC 60947, IEC60204, BS EN 60947, BS EN 60204															
KG10	20	690	-	20	1.1	2.2	3.7	1.5	3	5.5	20	2.5	1.5	-	
KG20	25	690	-	25	1.5	4	5.5	2.2	5.5	7.5	35	6	4	-	
KG32	32	690	-	32	2.2	5.5	7.5	3	5.5	11	35	6	4	-	
KG41	40	690	-	40	3	7.5	11	4	7.5	15	50	16	10	-	
KG64	63	690	-	63	4	11	18.5	5.5	11	22	63	16	10	-	
KG80	80	690	-	80	7.5	15	22	10	18.5	30	80	50	35	-	
KG100	100	690	-	100	8.5	18.5	30	11	22	37	100	50	35	-	
KG105	125	690	-	125	-	22	37	-	25	45	125	50	35	-	
KG125	125	1000 <sup>1</sup>	-	125	-	22	37	-	30	45	125	95	70	-	
KG160	160	1000 <sup>1</sup>	-	160	-	30	45	-	30	55	160	95	70	-	
KG210	200	1000 <sup>1</sup>	-	200	-	37	55	-	37	75	200	185	120	-	
KG250	250	1000 <sup>1</sup>	-	250	-	37	55	-	37	90	250	185	120	-	
KG315	315	1000 <sup>1</sup>	-	315	-	45	75	-	55	110	315	185	120	-	
KH16	16	800 <sup>1</sup>	-	16	1.5	3	5.5	2	4.5	7.5	25	6	4	-	
KH20	20	800 <sup>1</sup>	-	20	2	3.5	6.5	2.5	5.5	10	32	6	4	-	
KH25	25	800 <sup>1</sup>	-	25	2.5	4	7.5	3.3	7	12	35	6	4	-	
KH32	32	800 <sup>1</sup>	-	32	3	5.5	11	4.2	9	16	35	10	6	-	
KH40	40	800 <sup>1</sup>	-	40	4.5	7.5	15	5.5	11	20	50	10	6	-	
KH63	63	1000 <sup>1</sup>	-	63	7.5	11	22	8.5	18.5	30	80	35	25	-	
KH80	80	1000 <sup>1</sup>	-	80	10	15	30	11	23	40	100	35	25	-	
KH85	100	1000 <sup>1</sup>	-	100	10	-	-	11	-	-	100	35	25	-	
Auxiliary contacts - selection data in accordance with IEC 60947, BS EN 60947															
KG10	20	690	6	6	4	20	-	-	-	-	20	2.5	2.5	-	
KG20 & KG32	10	500	2.5	2.5	1.5	10 <sup>2</sup>	-	-	-	-	10	1.5	1.5	-	
KG41- KG105	16	690	6	6	3	16	-	-	-	-	16	2.5	2.5	-	
KG125- KG315	16	690	6	6	3	16	--	-	-	-	16	2.5	2.5	-	

Notes: 1) Only valid for no-load switching (AC-20A) above 690v. 2) Max 500v

Switch Rating or Utilization Category	Switch Selection - Common Rating Data and Utilization Categories Description
Rated insulation voltage U	Maximum value of operational voltage
Thermal current, I <sub>th</sub>	Maximum value of current that the switch can carry (not switch) when mounted in free air Max. ambient air temperature for stated value:- KG/KH switches +50°C average over 24hrs with peaks up to 55°C
AC-3	For the selection of switches used for starting of squirrel cage motors and switching off during running
AC-15	For the selection of switches used for the control of an a.c. electromagnetic load e.g. contactor coils
AC-21A	For the selection of switches required for switching of resistive loads, including moderate overloads
AC-23A	For the selection of switches required for switching motor loads or other highly inductive loads
	Normal selection criteria for emergency-off switches for motors and switches used for safety isolation of motors (switch-disconnectors) such as Off/On, main or main/emergency-off switches.



# CONNECTION DIAGRAMS

## Switch disconnectors

Off - On

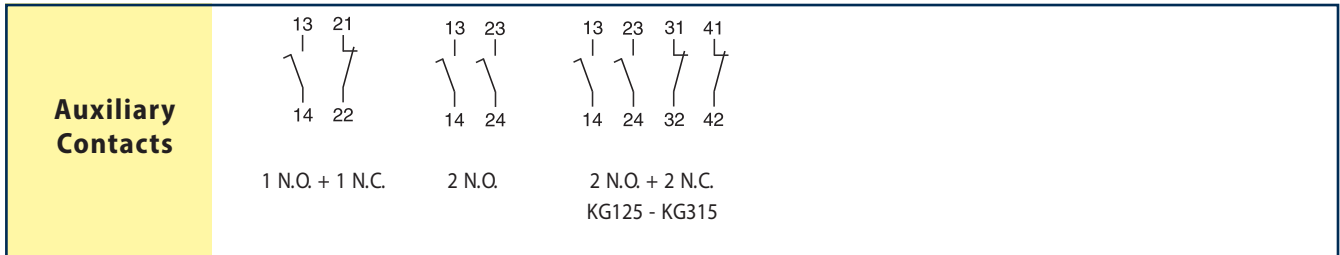
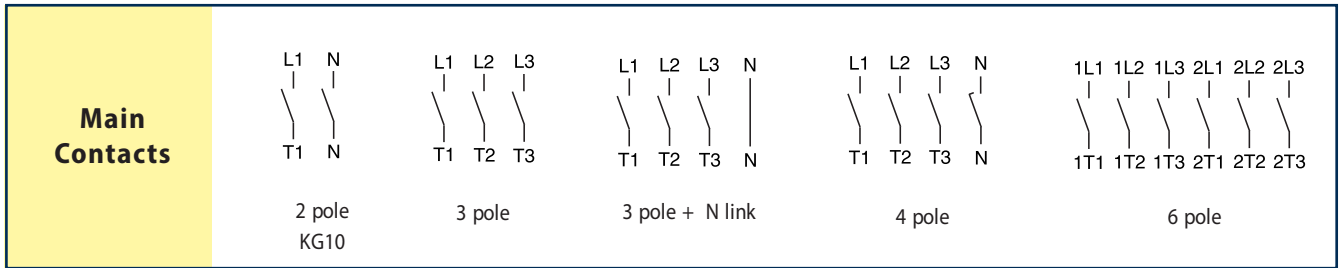

Changeover  
with Centre Off

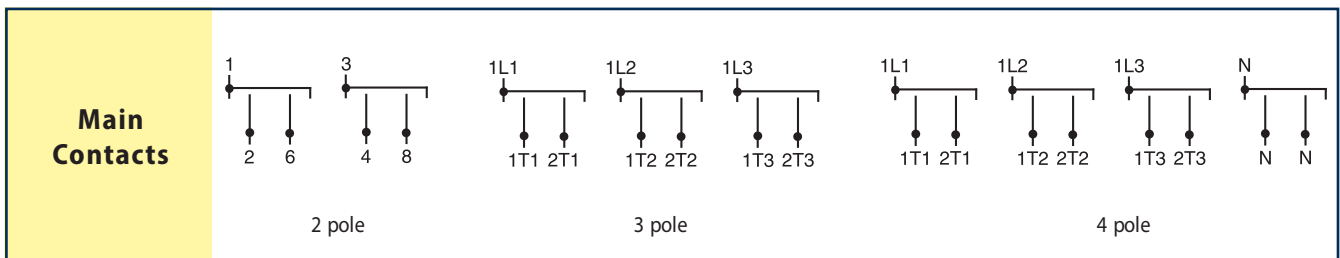

Side Mounting  
Auxiliary Contacts

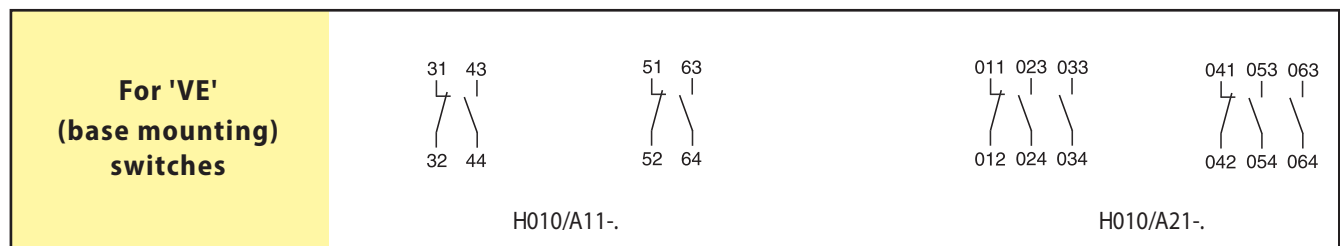
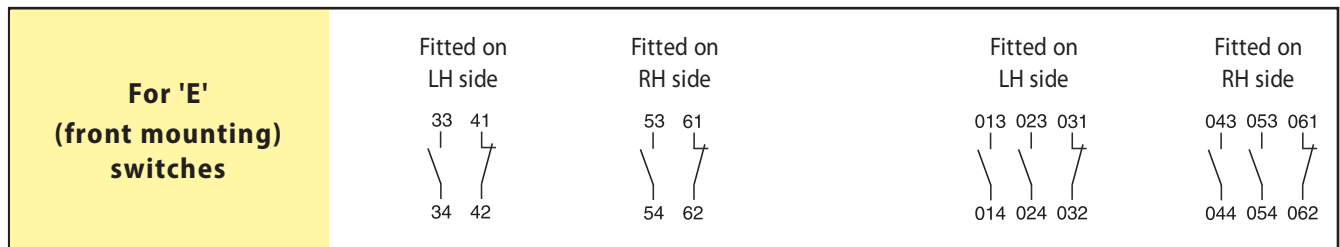

## DIMENSIONS (MM)

# KG Main/emergency-off switches

## Front Panel Mounting Single Hole Fixing

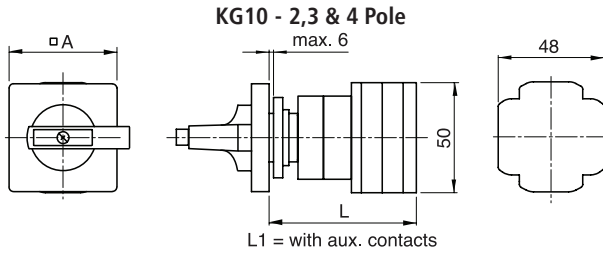

Mounting Hole

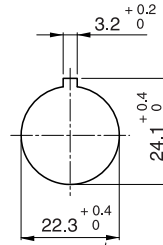

KG20 & KG32 - 3 & 4 Pole

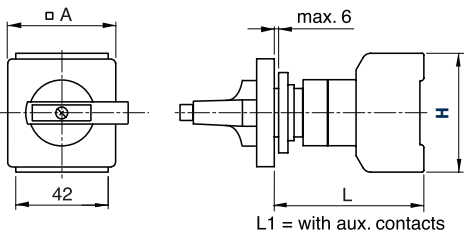

	A	H	L 2 Pole	L 3/4 Pole	L1 3/4 Pole
KG10A	48	-	57.4	66.9	76.4
KG20A, KG32A	48	54	-	68.3	77.3

## Front Panel Mounting Four Hole Fixing

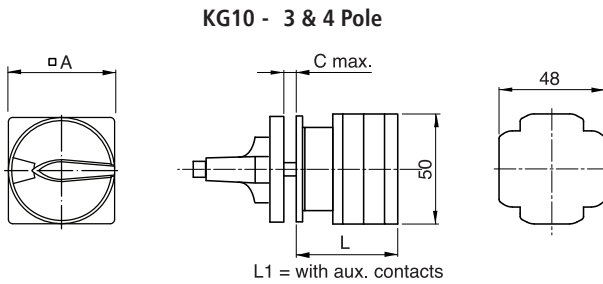

Mounting Holes

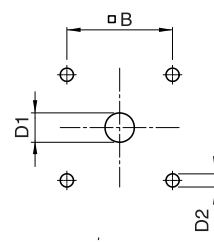

KG20 to KG105 - 3 & 4 Pole

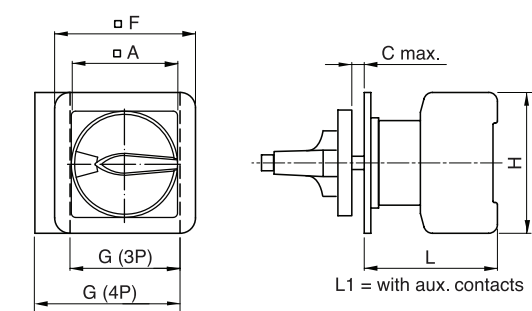

	A	B	C	D1	D2	F
KG10A	48	36	4	11 - 15	5	-
KG20A, KG32A	48	36	4	10 - 15	5	48
KG41B, KG64B	64	48	4	10 - 15	5	64
KG80, KG100, KG105	64	48	4	10 - 15	5	70
KG125, KG160	88	68	5.5	13 - 17	6	-
KG210, KG250, KG315	88	68	5.5	13 - 17	6	-

KG125 to KG315 - 3 & 4 Pole

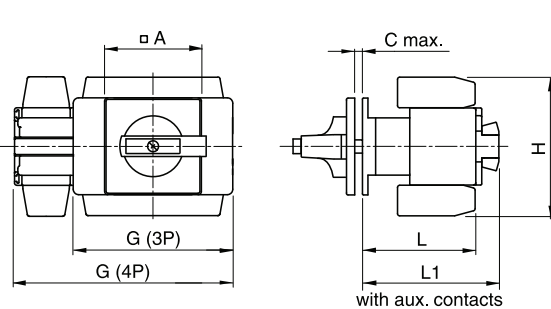

	G 3 pole	G 3 pole	H	L	L1
KG10A - 2 pole	-	-	-	38.7	-
KG10A - 3/4 pole	-	-	-	48.2	57.7
KG20A, KG32A	42	55.5	54	53.8	62.8
KG41B, KG64B	50	66	64	60.5	70.5
KG80, KG100	70	92	80	70.6	80.6
KG105	70	92	80	70.6	80.6
KG125, KG160	112	150	108	96	117
KG210, KG250, KG315	145	197.5	126	103	124

'H' dimension does not include the terminal covers. To obtain the dimension across the terminal cover(s) add the following to dimension 'H'.

- KG80/100/105: add 26 mm on side that cover is fitted.
- KG125/160: add 22.5 mm on side that cover is fitted
- KG210/250/315: add 50 mm to 'H' dimension

Factory fitted auxiliary contacts are integral with the main switch body – they are not side mounting type.

# Switch disconnectors

Base Mounting with Door Interlock

## 3, 3 + N & 4 Pole - plan view

KG10

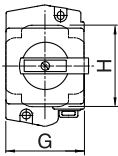

KG20 to KG105

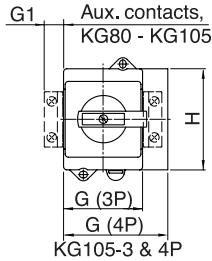

KG125 to KG315

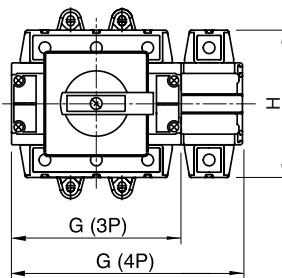

## 6 Pole - plan view

KG20 to KG105

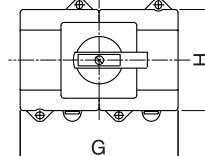

KG125 to KG160

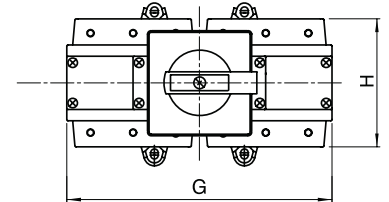

### Base Mounting Holes

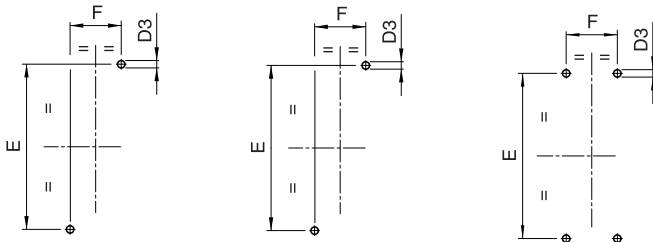

### Base Mounting Holes

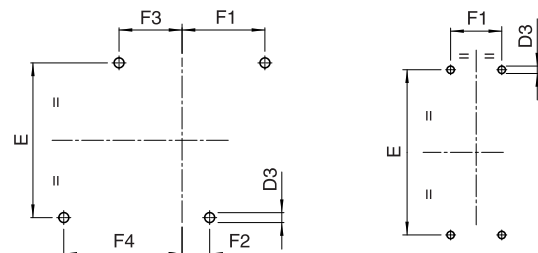

	D3	E	F	F1	F2	F3	F4	G 3 pole	G 3 pole+N	G 4 Pole	G 6 Pole	G1	H
KG10A & B	5	60	22	--	-	-	-	48	-	48	-	-	50
KG20A -& B, KG32A & B	5	60	22	32	10	10	32	42	55.5	55.5	84	-	54
KG41B, KG64B	5	70	25	37.5	12.5	12.5	37.5	50	66	66	100	-	64
KG80, KG100	6	90	25	47.5	22.5	22.5	47.5	70	92	92	140	12.2	80
KG105	6	90	25	-	-	-	-	70	92	92	140	12.2	80
KG125, KG160	6.4	120	36	76	-	-	-	112	-	150	224	-	108
KG210, KG250, KG315	6.4	142	44	-	-	-	-	145	-	197.5	-	-	126

'H' dimension does not include the terminal covers. To obtain the dimension across the terminal cover(s) add the following to dimension 'H'.

KG80/100/105: add 26 mm on side that cover is fitted.

KG125/160: add 22.5 mm on side that cover is fitted

KG210/250/315: add 50 mm to 'H' dimension

Factory fitted auxiliary contacts are integral with the main switch body – they are not side mounting type.

Note: Handle styles vary - see relevant catalogue section for handle style used.

## Defeatable Door Interlock, Single Hole Fixing. 3 & 4 Pole Switches

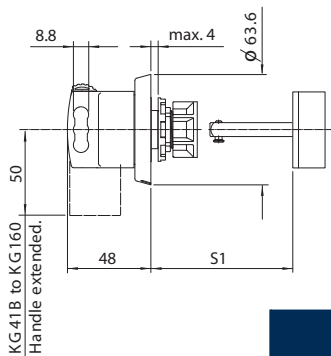

## Door Interlock, Single Hole Fixing. 3, 3+N, 4 & 6 Pole KG10 to KG105

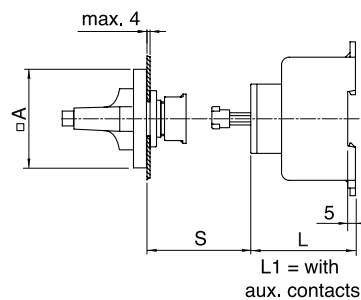

## Handle Mounting Hole

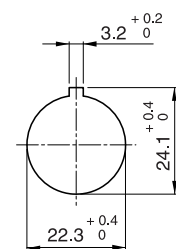

	A	L1 3/4 Pole	L1 3/4 Pole	S	S1 3/4 Pole	L 6 Pole	L1 6 Pole	S 6 Pole
KG10A	48	49.2	58.7	30- 191	-	-	-	-
KG20A, KG32A	48	50	59	31-196	-	-	-	-
KG20B, KG32B	64	50	59	-	47-202mm	57.5	66.5	31-199
KG41B, KG64B	64	61	71	31-192	31-202mm	67	77	31-193
KG80, KG100, KG105	64	68	78	32-189	32-202mm	79.2	89.2	32-189
KG125, KG160	-	91	91	-	34-263mm	-	-	-

## DIMENSIONS (MM)

# KG Main/emergency-off switches

### Base Mounting with Door Interlock, cont'd

#### Door Interlock, 4 Hole Fixing. 3, 4 & 6 Pole Switches - side view.

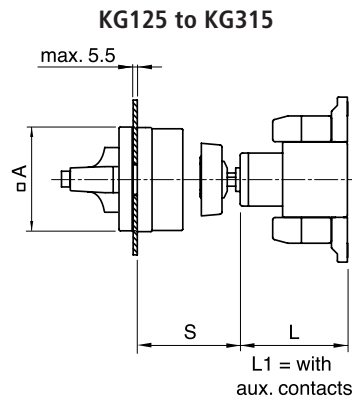
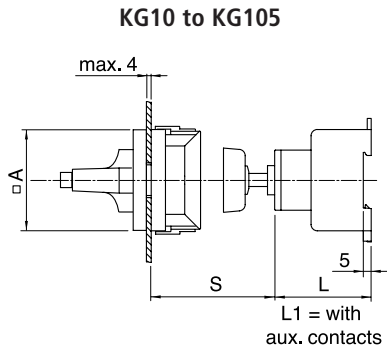

#### Handle Mounting Holes

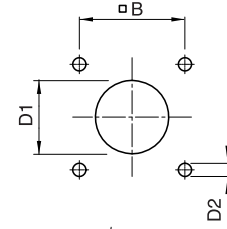

	Shaft Length	A	B	D1	D2	L	L1	S	L	L1	S
KG10A	200	48	36	18-22	5	49.2	58.7	37-197	-	-	-
KG20A, KG32A	200	48	36	18-22	5	50	59	37-202	-	-	-
KG20B, KG32B	200	64	48	19-22	5	-	-	-	57.5	66.5	37-205
KG41B, KG64B	200	64	48	19-22	5	61	71	35-200	67	77	35-201
KG80, KG100, KG105	200	64	48	19-22	5	68	78	36-197	79.2	89.2	36-197
KG125, KG160	300	88	68	26-30	6	91	91	45-306	93	93	45-306
KG210, KG250, KG315	300	88	68	26-30	6	98	98	45-306	-	-	-

#### Defeatable Door Interlock, 4 Hole Fixing. 3, 4 & 6 Pole Switches - side view.

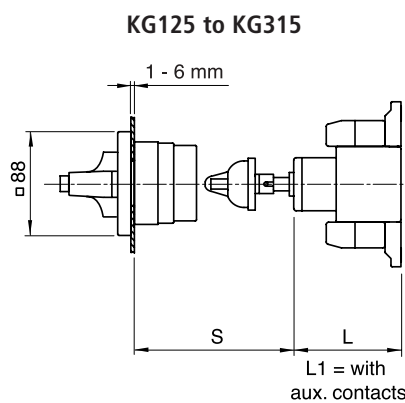
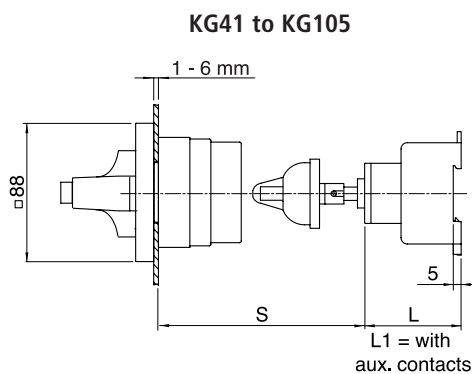

#### Handle Mounting Holes

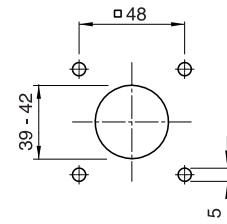

	L 3/4 Pole	L1 3/4 Pole	S 3/4 Pole	L 6 Pole	L1 6 Pole	S 6 Pole
KG41B, KG64B	61	71	72-224	67	77	72-225
KG80, KG100, KG105	68	78	73-221	79.2	89.2	73-221
KG125, KG160	91	91	83-336	93	93	83-336
KG210, KG250, KG315	98	98	83-336	-	-	-

# KG Changeover switches

Base Mounting with Door Interlock, 4 Hole Fixing

KG20 to KG105 - 3 & 4 Pole

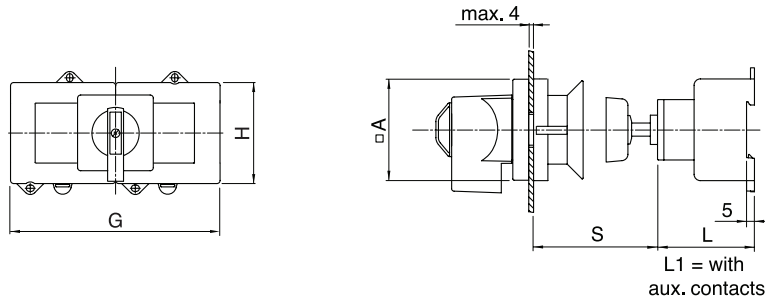

Base Mounting Holes

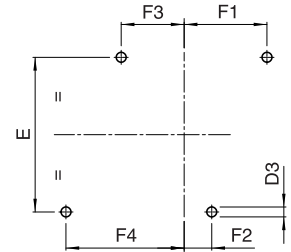

KG125 to KG160 - 3 & 4 Pole

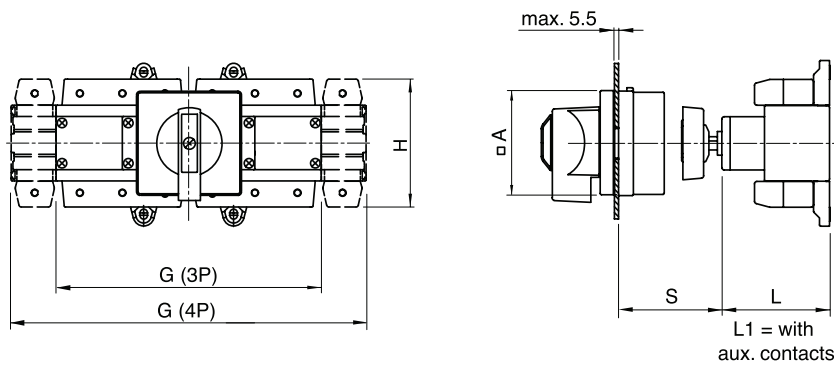

Base Mounting Holes

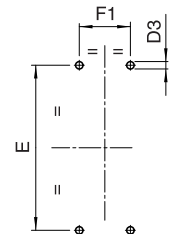

	A	B	D1	D2	D3	E	F1	F2	F3 3 Pole
KG20B, KG32B	64	48	19-22	5	5	60	32	10	10
KG41B, KG64B	64	48	19-22	5	5	70	37.5	12.5	12.5
KG80, KG100	88	48	19-22	5	6	90	47.5	22.5	22.5
KG105	88	48	19-22	5	6	90	47.5	22.5	-
KG125, KG160	88	68	26-30	6	6.4	120	76	-	-

Handle Mounting Holes

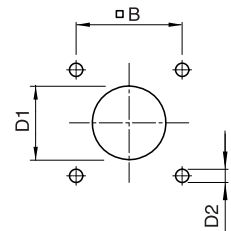

	F4 3 Pole	F3 4 Pole	F4 4 Pole	G 3 Pole	G 4 Pole	H	L	L1	S
KG20B, KG32B	32	23.5	45.5	84	111	54	57.5	66.5	37-125
KG41B, KG64B	37.5	28.5	53.5	100	132	64	67	77	35-131
KG80, KG100	47.5	44.5	69.5	140	184	80	79.2	89.2	36-127
KG105	-	44.5	69.5	140	184	80	79.2	89.2	36-127
KG125, KG160	-	-	-	224	300	108	93	93	45-196

Factory fitted auxiliary contacts are integral with the main switch body – they are not side mounting type.

## DIMENSIONS (MM)

# KG Changeover switches

Base Mounting - For 45mm Installation Cut-Out

KG41 to KG105 - 4 Pole

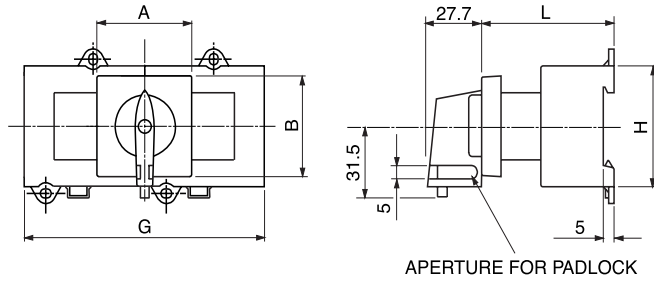

Mounting Holes

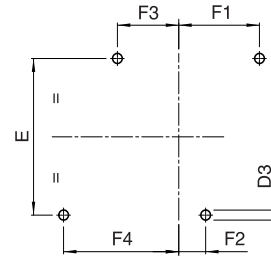

	A	B	D3	E	F1	F2	F3	F4	G	H	L
KG41B, KG64B	105.4	45.4	5	70	37.5	12.5	28.5	53.5	132	64	67.5
KG80, KG100, KG105	70	45	6	90	47.5	22.5	44.5	69.5	184	80	81.2

## KG Switch options

Side Mounting Modules

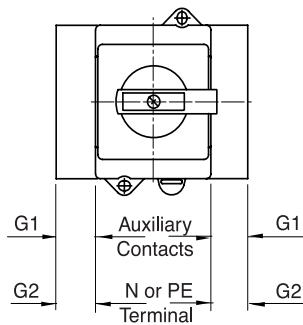

Terminal Covers

KG10 to KG105

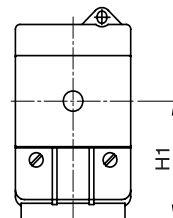

KG125 to KG315

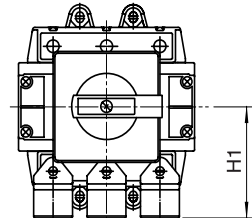

	G1	G2
KG20A & B, KG32A & B	10	13.5
KG41B, KG64B	11	16
KG80, KG100, KG105	11	22
KG125, KG160	14	38
KG210, KG250, KG315	14	52.5

	H1
KG10A & B	32
KG20A & B, KG32A & B	47
KG41B, KG64B	49
KG80, KG100, KG105	66
KG125, KG160	76.2
KG210, KG250, KG315	88

**Note:**  
KG125 to KG315 4 pole switches cannot have additional modules fitted on the side adjacent to the 4th pole (switched neutral).

# KH Changeover switches

Base Mounting with Door Interlock, 4 Hole Fixing

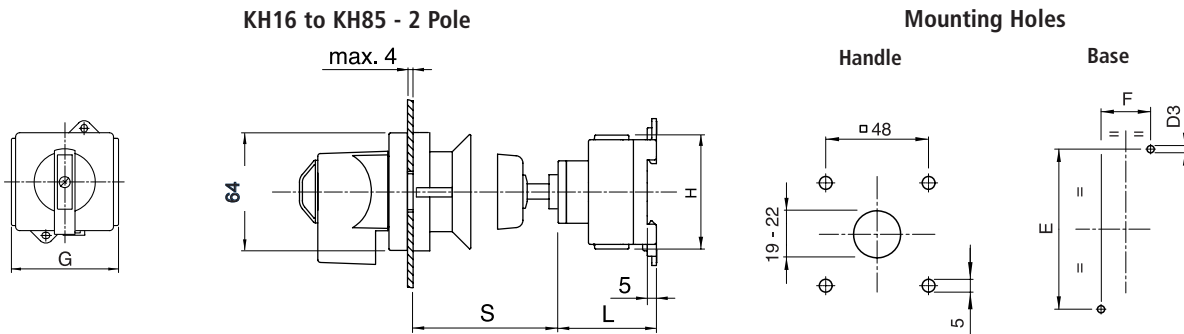

'H' dimension for KH63/80/85 does not include the terminal cover. To obtain the dimension across the terminal cover(s) add 23.5 mm on side that cover is fitted.

	D3	E	F	G	H	L	S
KH16, KH20, KH25	5	60	22	60	56	47	37-122
KH32, KH40	5	70	25	70	62	53.5	39-132
KH63, KH80, KH85	6	90	25	86	90	59.5	39-132

Base Mounting - For 45mm Installation Cut-out

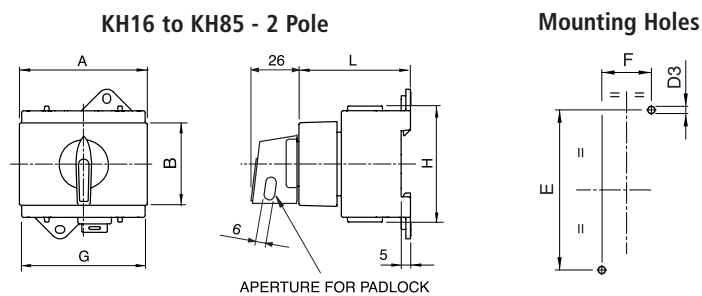

	A	B	D3	E	F	G	H	L
KH16, KH20, KH25	43.7	45.4	5	60	22	60	56	58.5
KH32, KH40	70.4	45.4	5	70	25	70	62	59.7
KH63, KH80, KH85	70.4	45.4	5	90	25	86	90	66.7

## KH Switch options

Terminal Covers

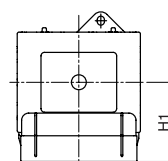

	H1
KH32, KH40	45
KH63, KH80, KH85	68.5