

KGD40-DC-Lasttrennschalter für Photovoltaik-Anlagen

DC-Lasttrennschalter der KGD40-Reihe, welche zur Freischaltung von Photovoltaik-Anlagen verwendet werden, müssen entsprechend der Tabelle ausgewählt werden. Die notwendige Reihenschaltung von Kontakten im Stromkreis muss mittels separat erhältlichen Verbindern hergestellt werden.

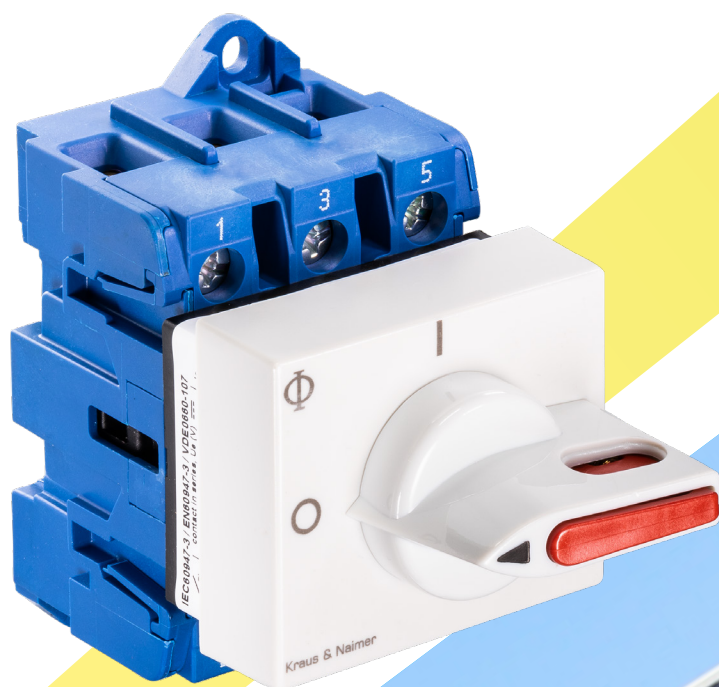

KGD40 PV-Lasttrennschalter

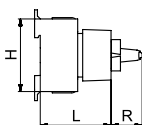
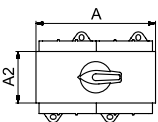
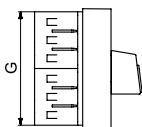
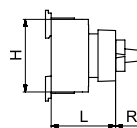
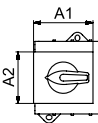
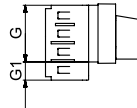
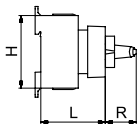
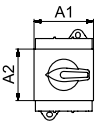
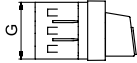
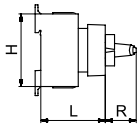
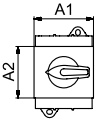
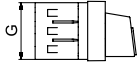

2 Kontakte

Bezeichnung	Art.-Nr.
KGD40.TD302.VE2.AT2PV	70058577

G	G1	H	L	R	A1	A2
50	-	64	56,5	27,5	52,4	45,4

3 Kontakte

Bezeichnung	Art.-Nr.
KGD40.TD303.VE2.AT2PV	70058574

G	G1	H	L	R	A1	A2
50	-	64	56,5	27,5	52,4	45,4

4 Kontakte

Bezeichnung	Art.-Nr.
KGD40.TD304.VE2.AT2PV	70058573

G	G1	H	L	R	A1	A2
50	16	64	56,5	27,5	52,4	45,4

6 Kontakte

Bezeichnung	Art.-Nr.
KGD40B.TD306.VE2.AT2PV	70058575

G	G1	H	L	R	A1	A2
100	-	64	62,5	27,5	105,4	45,4

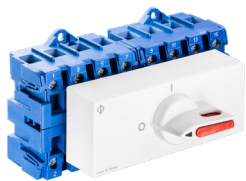

8 Kontakte

Bezeichnung	Art.-Nr.
KGD40B.TD308.VE2.AT2PV	70058576

G	G1	H	L	R	A1	A2
132	-	64	62,5	27,5	105,4	45,4

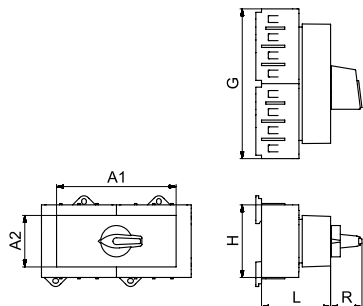

Umschalter, 4 Kontakte

Bezeichnung	Art.-Nr.
KGD40B.TD994.VE2.AT2PV	70068069

G	G1	H	L	R	A1	A2
132	-	64	62,5	27,5	105,4	45,4

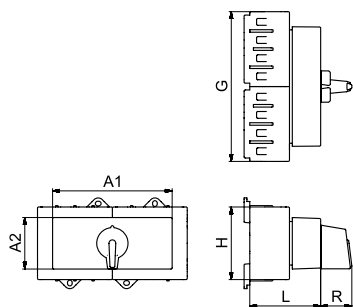
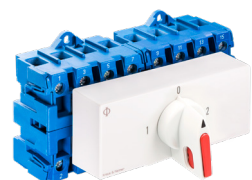

Verbinder

Bezeichnung	Art.-Nr.
K1B.D220.24S	2219571



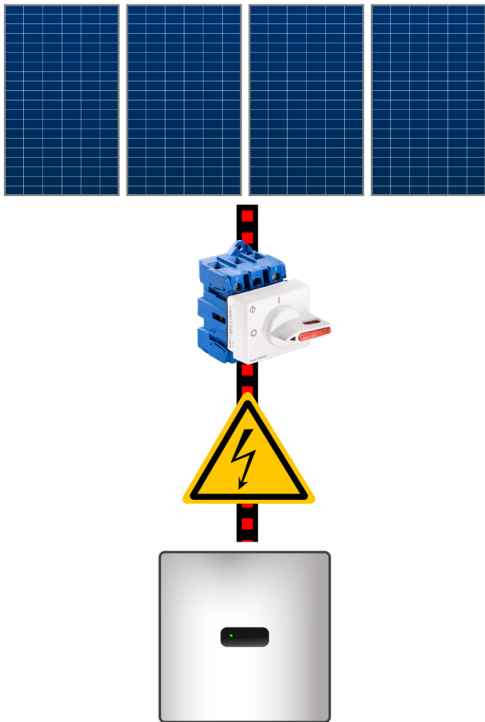

Beispiel: String hat 15 Module mit U_{MPP} : 41,5V I_{MPP} : 10,24A

Ergibt für diesen String 622,5 Volt und 10,24 Ampere.

Laut Tabelle benötigen Sie für diesen String daher 2 Kontakte im DC-Stromkreis. Eine allpolige Abschaltung ist empfehlenswert. Benötigen Sie 3 oder mehr Kontakte pro String, müssen Sie eine Serienschaltung der Kontakte mittels Verbindern selbst herstellen.

Gebrauchskategorie	Gleichspannung (V)	Strom (A)	Kontakte in Serie
DC-PV2	125	50	1
DC-PV2	180	40	1
DC-PV2	250	30	1
DC-PV2	250	50	2
DC-PV2	320	40	2
DC-PV2	330	20	1
DC-PV2	370	40	2
DC-PV2	375	50	3
DC-PV2	400	12	1
DC-PV2	480	40	3
DC-PV2	500	30	2
DC-PV2	500	50	4
DC-PV2	560	40	3
DC-PV2	640	40	4
DC-PV2	660	20	2
DC-PV2	750	30	3
DC-PV2	750	40	4
DC-PV2	750	50	6
DC-PV2	800	12	2
DC-PV2	950	34	4
DC-PV2	1000	20	3
DC-PV2	1000	30	4
DC-PV2	1000	40	6
DC-PV2	1000	50	8

Kraus & Naimer

Kraus & Naimer GmbH

Schumanngasse 39

1180 Wien

Austria

T: +43 1 404 06

E: sales-at@krausnaimer.com

www.krausnaimer.com